



MSEM

MOTOR STARTER ENERGY MANAGEMENT

Installation & Operation Manual



SAFETY PRECAUTIONS

To prevent injury and property damage, follow these instructions. Failure to adhere to installation/operation procedures and all applicable codes may result in hazards as indicated by warning codes below:

DANGER

Indicates an imminently hazardous situation which, if not avoided, will result in death or serious injury. This signal word is to be limited to the most extreme situations.

WARNING

Indicates a potentially hazardous situation which, if not avoided, could result in death or serious injury.

CAUTION

Indicates a potentially hazardous situation which, if not avoided, may result in minor or moderate injury. It may also be used to alert against unsafe practices.



This is the safety alert symbol. Read and follow instructions carefully to avoid a dangerous situation.



This symbol alerts the user to the presence of “dangerous voltage” inside the product that might cause harm or electrical shock.

CAUTION

As with all electrical products, read manual thoroughly. Only qualified, expert personnel should perform maintenance and installation. Contact the nearest authorized service facility for examination, repair, or adjustment. Do not disassemble or repair unit unless described in this manual; death or injury to electrical shock or fire hazard may result. Specifications and manual data are subject to change. Consult factory for additional information.

DANGER

Equipment can start automatically. Lockout/tagout before servicing

Table of Contents

1. Introduction	3
2. Specifications	4
• Motor Protection	5
• SCM Meter Base	6
• Control Terminals	7
• MSEM Control Terminals	7
3. Installation / Wiring	9
• Torque Specifications	9
• MSEM Wiring Diagrams	10
4. Operation	12
• Control	12
• Lockout Feature / Advanced Settings Lockout	13
• Setting Adjustments	14
• Advanced Settings Menu Structure	15
• Display Features	21
• Fault and Alarm Descriptions	23

Appendix

A. Overload and Ground Fault Trip Curves	25
• Overload Trip Curves	25
• Ground Fault Trip Curve	26
B. Ground Fault Test Procedure	27
C. Option Boards	28
• Ethernet I/O (Fault Logging)	28
• Tru-Power™ (Power Meter)	29
• BACnet	30
• Modbus RTU	31
D. Warranty Information	32

1. Introduction

Overview

The Greenheck Fan Corp. Starter Control Module (**SCM**) consists of a customer interface board assembly in combination with a meter base, which provides 1 or 3 phase AC motor control, motor protection, and power metering. The SCM provides motor control and protection for the Greenheck Fan Corp. **MSEM** series starters.

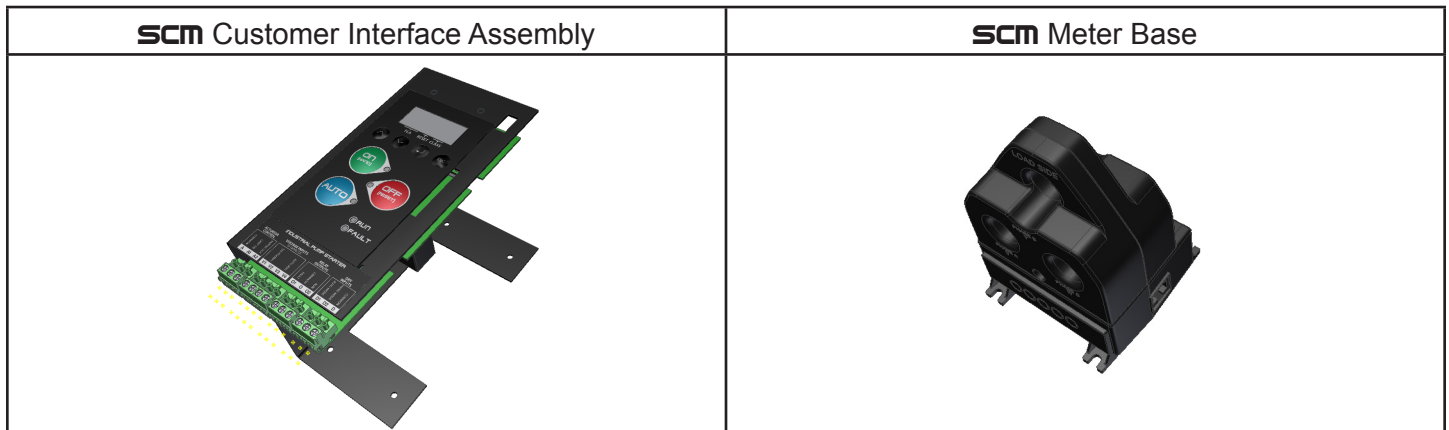

Additional optional circuit boards may be added to **MSEM** series starters. Features include:

- 1) Power Metering Option Board
 - Provides energy metering on both a kWh pulse output and a 4-20mA analog kW measurement output terminal.
- 2) BACnet Communications Option Board (MSEM)
 - Provides Building Automation and Control Network (BACnet) Master Slave Token Passing (MS/TP) data link protocol communications. Also provides one dry contact digital input, one output relay, and an analog input, configurable to support 4-20mA, 0-10V, and 10K Thermistor input signals.
- 3) Modbus RTU Communications Option Board
 - Provides Modbus RTU Communications support. Provides two programmable dry contact digital inputs as well as an analog input, configurable to support 4-20mA, 0-10V, and 10K Thermistor input signals.
- 4) Ethernet Fault Logging Option Board
 - Provides data/fault logging, date and time stamped, with power conditions for up to 100 events.

*For detailed descriptions of MSEM option boards, see Appendix C

Applications

- MSEM**: Across-the-line starter for HVAC motor control and Building Automation

Features

- LCD Energy Display - kW, kVA, kVAR, kWh
- Power Monitoring
- Motor Protection
- Motor Control - HOA keypad
- Combination versions feature a molded case circuit breaker or MMS disconnect.

Motor Protection Overview	
Protection	MSEM
Electronic Overload	Yes
Overload Trip Class	5-30
Phase Unbalance	Yes
Phase Loss	Yes
Reverse Phase	Yes
Cycle Fault	Yes
Locked Rotor	Yes
Ground Fault	Yes
Under Power	Yes
Over Power	Yes
Out of Calibration	Yes
Max Time to Start	Yes
Over/Under Voltage	Yes
Backspin Delay	Yes
ON Delay	Yes
Warm Start Provision	Yes
Cool Down Profile	Yes
Automatic/Manual Reset	Yes

2) Specifications

Motor Protection Descriptions

Feature	Description
Overload	Selectable Class 5-30, trips within inverse trip curve (see Appendix A)
Ground Fault	UL 1053 ground fault protection (see Appendix A for trip curves, Appendix B for test procedure)
Locked Rotor	Trips within 0.5 seconds upon locked rotor detection
Cycle Fault	Trips when motor contact closure exceeds a rate of 20 closures/minute
Out of Calibration	Trips in 10 seconds if measured inrush current is less than 400% or greater than 1400% of FLA setting.
Max. Time to Start	Trips after 10 seconds if current is still above 200% of FLA and decreasing.
Under Power	Trips if the measured nominal HP falls below selectable level (1-99%)
Over Power	Trips if the measured nominal HP rises above selectable level (1-99%)
Over / Under Voltage	Trips if the measure voltage is above or below the selectable level ($\pm 5\%$ -25%)
Voltage Phase Unbalance	Trip when the percentage of deviation between any one phase and the average voltage is greater than the selected % level. (1%-20%)
Voltage Reverse Phase	Trips if voltage phases are reversed
Current Phase Unbalance	Trip when the percentage of deviation between any one phase and the average current is greater than the selected % level. (1%-50%)

Default Settings

Feature	mSEM
Overload	Class 10
Service Factor	1.15
Locked Rotor	On
Cycle Fault	On
Out of Calibration	On
Max. Time to Start	On
Under Power	On / 50%
Over / Under Voltage	On / 10%
Voltage Phase Unbalance	On / 5%
Voltage Reverse Phase	On
Current Phase Unbalance	On / 20%

Meter Base Layout and Terminal Descriptions

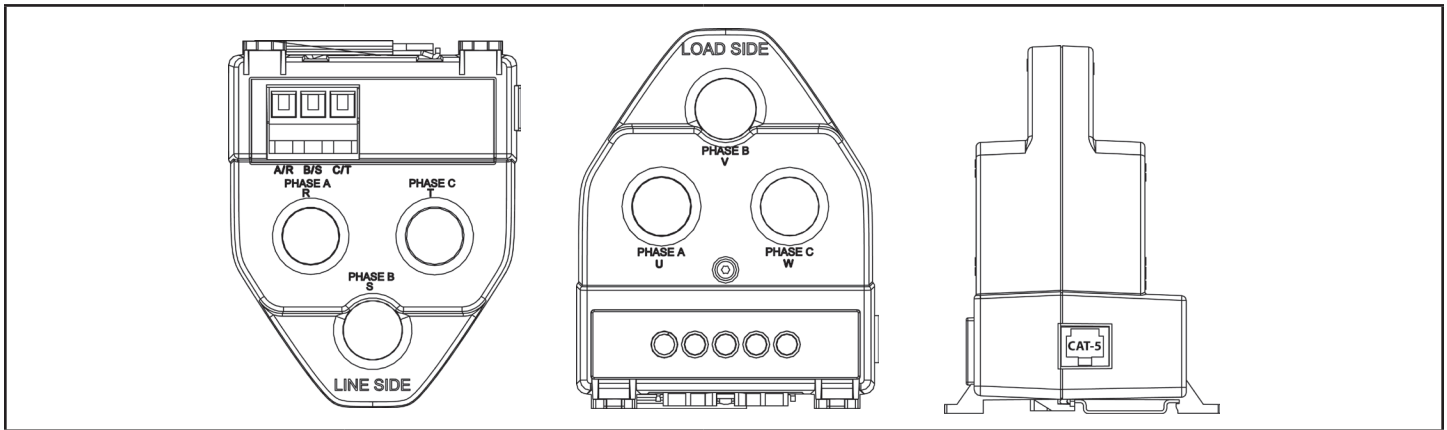

Name	Type	Description	Details
A/R	Terminal	Phase A voltage taken from line side or contactor	Max 600VAC, 24-10 AWG wire
B/S	Terminal	Phase B voltage taken from line side or contactor	Max 600VAC, 24-10 AWG wire
C/T	Terminal	Phase B voltage taken from line side or contactor	Max 600VAC, 24-10 AWG wire
CAT-5	CAT-5	Connection to SCM control board	Non-crossover CAT-5 cable only. Connect to SCM Customer Interface Board only.
PHASE A	Tunnel	Current measurement on Phase A	Max 1/0 AWG. Feed phase A load wire through tunnel and connect to contactor. Ensure "LOAD SIDE" faces motor and "LINE SIDE" faces contactor terminals.
PHASE B	Tunnel	Current measurement on Phase B	Max 1/0 AWG. Feed phase B load wire through tunnel and connect to contactor. Ensure "LOAD SIDE" faces motor and "LINE SIDE" faces contactor terminals.
PHASE C	Tunnel	Current measurement on Phase C	Max 1/0 AWG. Feed phase C load wire through tunnel and connect to contactor. Ensure "LOAD SIDE" faces motor and "LINE SIDE" faces contactor terminals.

SCM Main Circuit Board Terminal Descriptions

MSEM Control Terminals		
Symbol	Name	Description
Actuator - Motor output supplies same voltage as control power input. 24VAC (optional 120VAC) for actuator motor. Normally open dry contact or transistorized input for actuator limit switch input.		
A	Common	Common terminal for actuator motor and actuator limit input.
A1	Limit Switch Input (NO)	When active (closed), the actuator is in position.
A2	Motor Output (NO)	Provides voltage to the actuator motor when the starter commands the (primary) motor to start. The primary motor will be disabled until the actuator is in position.
Voltage Inputs - Apply 10-120VAC/DC, 10mA Max to energize		
V1-V2	Fireman's Override	When active (closed), the starter will command the motor to start in all modes and will supersede Shutdown. All mode LEDs will blink.
V3-V4	Auto Run	When active (energized), the starter will start the motor in Auto Mode.
Relay Outputs - Relay contacts rated for: 0.3A @ 125VAC, 1A @ 24VDC		
O1	Fault (NO)	When active (closed), a fault has occurred and the starter is no longer running.
O	Common	Common terminal for Fault and Run Output.
O2	Run (NO)	When active (closed), the motor is running and there is proof of flow.
Dry Inputs -		
D1	Auto Dry (NO)	Default: When active (closed), the starter will start the motor in <u>Auto Mode</u> .
	Permissive Auto (NO)	Option: When inactive (open), the Auto Dry and Auto Voltage Inputs are disabled.
D2	Shut Down (NC)	Default: When active (open), the starter will stop the motor in all <u>modes (except when Fireman's Override is in effect)</u> .
	Permissive Auto (NO)	Option: When inactive (open), the Auto Dry and Auto Voltage Inputs are disabled.
D	Common	Common terminal for D1/D2 Dry inputs.

MSEM Power Connections (Factory wired)		
PWR	Control Power Input	24VAC
COIL	Contactor Coil Output	Supplies same voltage as control power input.
CAT-5	CAT-5 Connection	Non-crossover CAT-5 cable only. Connect to SCM Meter Base only.

3) Installation/Wiring



DANGER

HAZARDOUS VOLTAGE

- Disconnect and lock out all power before installing or servicing equipment.
- This equipment may require locking out multiple power sources prior to service
- Install and wire in accordance with all applicable local & national electrical and construction codes

FAILURE TO FOLLOW THESE INSTRUCTIONS MAY RESULT IN DEATH OR SERIOUS INJURY

Mounting

Mount the starter on a vertical surface, with the line terminals facing up.



WARNING

- To maintain overcurrent, short-circuit, and ground-fault protection, the manufacturer's instructions for selecting current elements and setting the instantaneous-trip circuit breaker must be followed.
- Tripping of the instantaneous-trip circuit breaker is an indication that a fault current has been interrupted. Current-carrying components of the magnetic motor controller should be examined and replaced if damaged to reduce the risk of fire or electric shock.
- Do not locate starter in an environment subject to flammable gases, dusts or materials. Contact arcing can induce explosion or fire.
- Locate starter in a location appropriate to enclosure ratings and operational ratings.
- Do not allow any metal shavings or debris from installation to enter enclosure.

Wiring

Wire main power input and motor leads to the appropriate terminals tightened to specified torques indicated in the Torque Table. Use only copper conductors rated at least 60°C for applications less than 100A and at least 75°C \geq 100A. Maintain proper clearances and verify that no possibility of an electrical short exists between the power conductors or enclosure. Ensure that wires are not under stress and all insulation is intact. Verify voltage input matches label and the control power is tapped per schematic.

Terminal Torque Specifications

Low Voltage Wiring

Automation system control wiring should be run in a separate conduit.

The control terminals accept 26~14AWG wire torqued to 3.5 in-lb.

Power Wiring Torque Table (lb-in)			
NEMA Size	MSEM		
	Input		Output T1-T2-T3
	MMS Disconnect	No Disconnect	
	L1-L2-L3	L1-L2-L3	
00~1	60	20	35
2	90	35	35
3	150	35	35
3+	NA	NA	35
4	375	49.5	49.5
5	375	200	200
5+	375	200	200

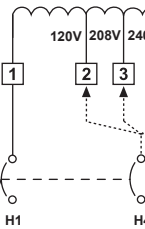
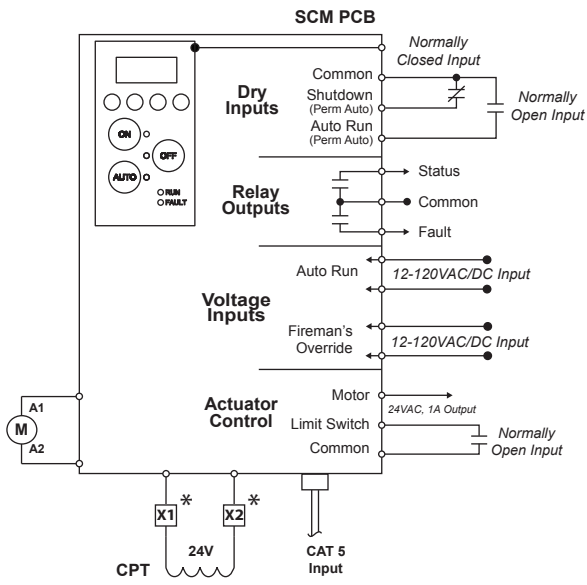

TRANSFORMER PRIMARY CIRCUIT BREAKER SIZING

VA	V	208/230	480
50VA		N/A	N/A
100VA		2A	1A

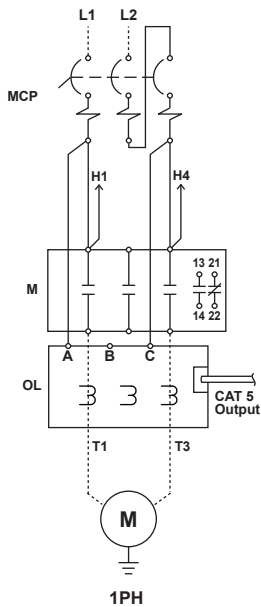

1PH

*X1 and X2 Terminals do not apply for Type 1 enclosed configurations

SCHM-MSEM/C-V3

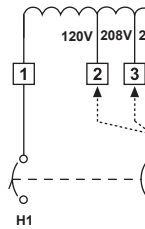
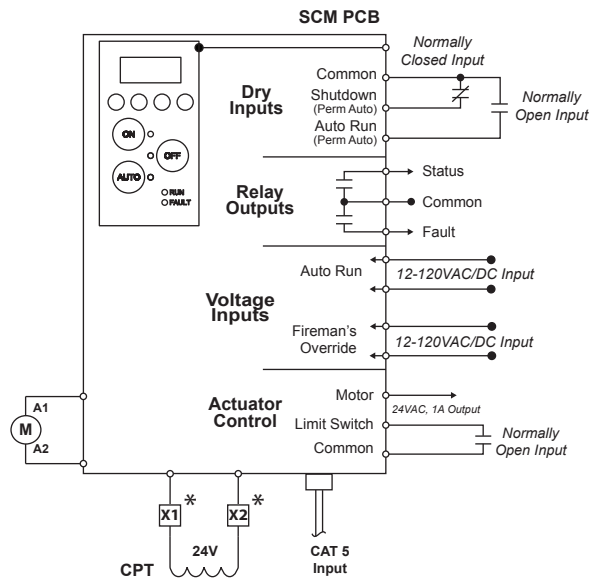

TRANSFORMER PRIMARY CIRCUIT BREAKER SIZING

VA	V	208/230	480
50VA		N/A	N/A
100VA		2A	1A

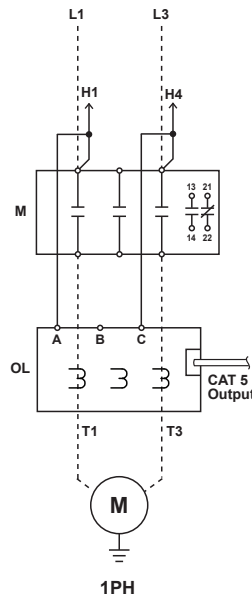

1PH

*X1 and X2 Terminals do not apply for Type 1 enclosed configurations

SCHM-MSEM/S-V3

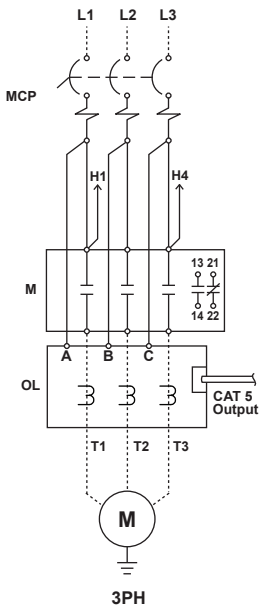

3PH

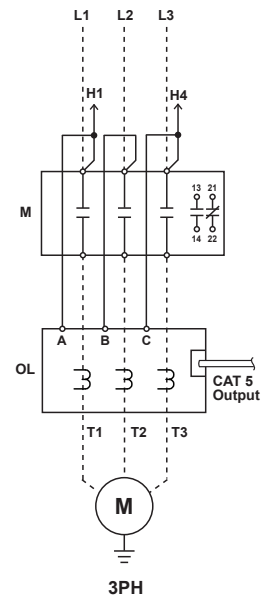

3PH

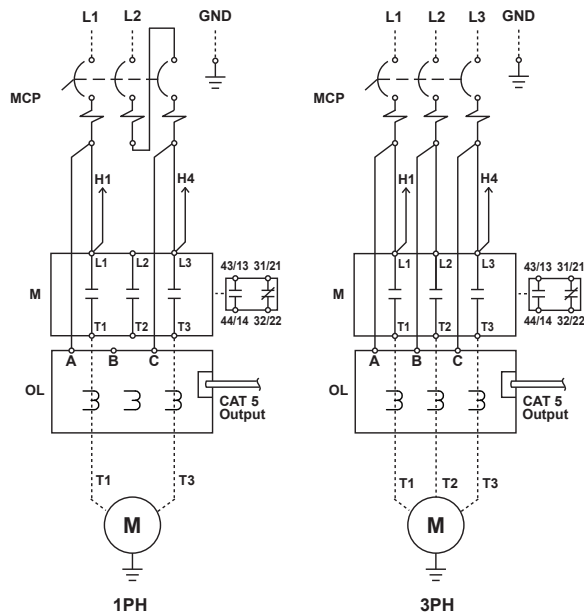
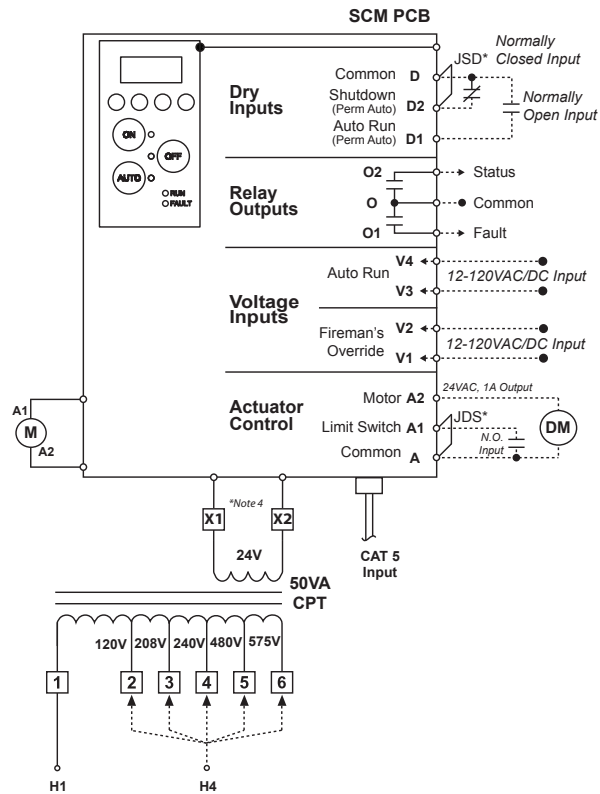

- NOTES:**
1. DASHED LINES INDICATE FIELD WIRING
 2. REMOVE JUMPER JDS TO WIRE LIMIT SWITCH
 3. REMOVE JUMPER JSD TO WIRE SHUTDOWN INPUT
 4. X1 AND X2 TERMINALS APPLY FOR TYPE 3R ENCLOSED STARTERS ONLY

SCHM-MSEM/C/50VA-V1

MSTS Wiring Schematic (MSTSXX-9~MSTSXX-85)

WIRING DIAGRAM MSTS-2S: SCM 2-SPEED, 2-WINDING STARTER (MSEM)

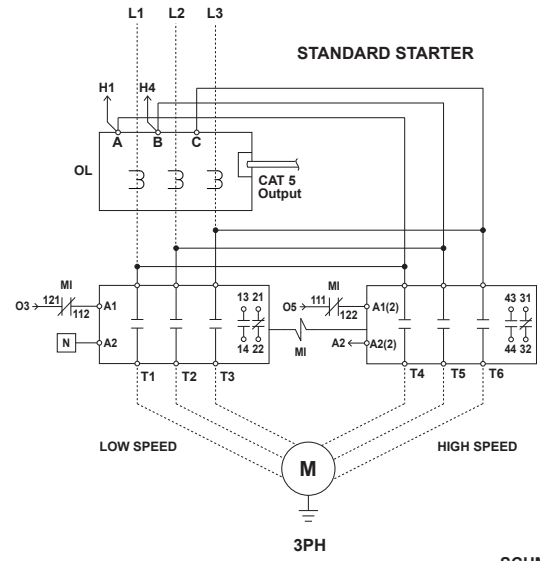
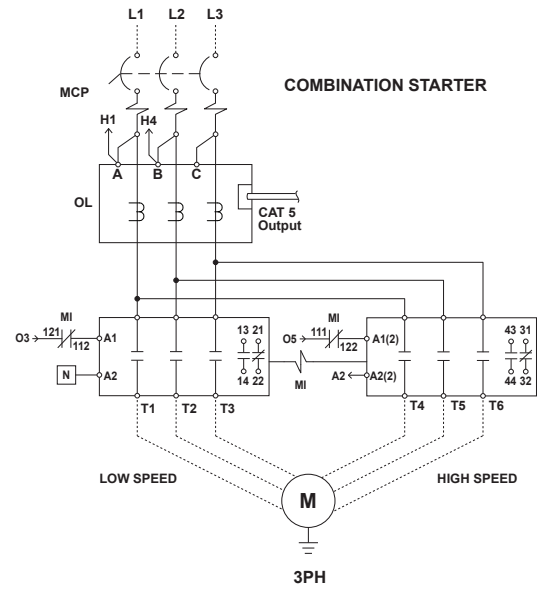
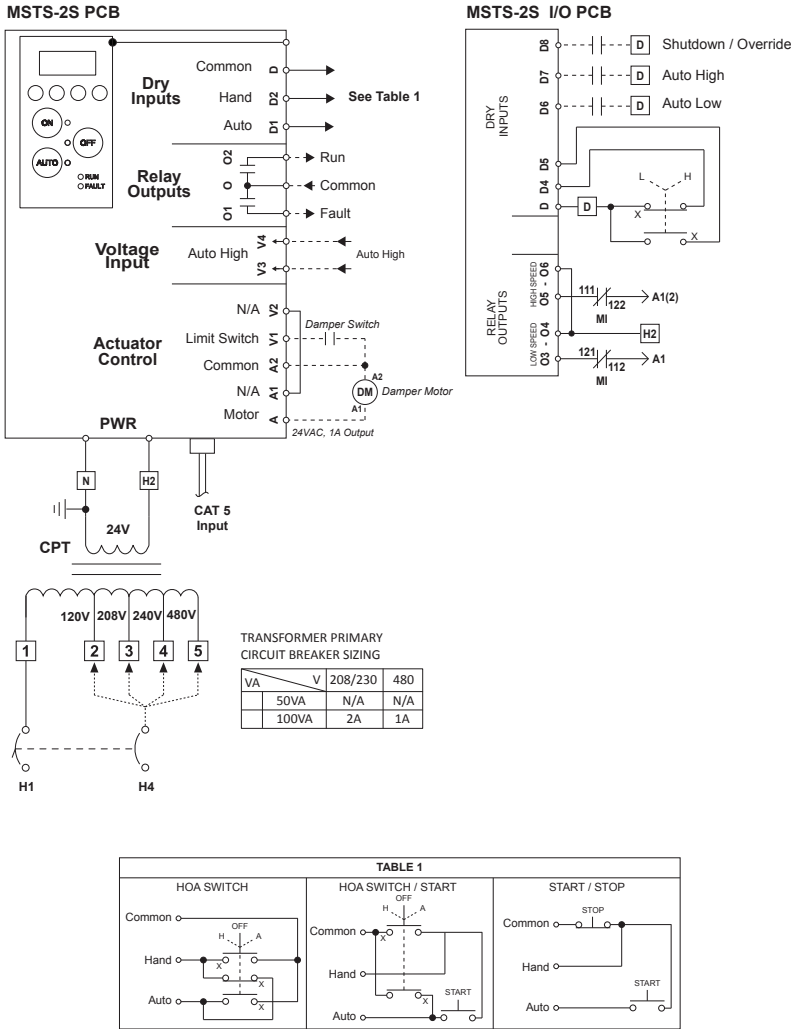

SCHM-MSTS-2S-V1

WIRING DIAGRAM
MS-2S: SCM 2-SPEED, 2-WINDING STARTER (IPS)

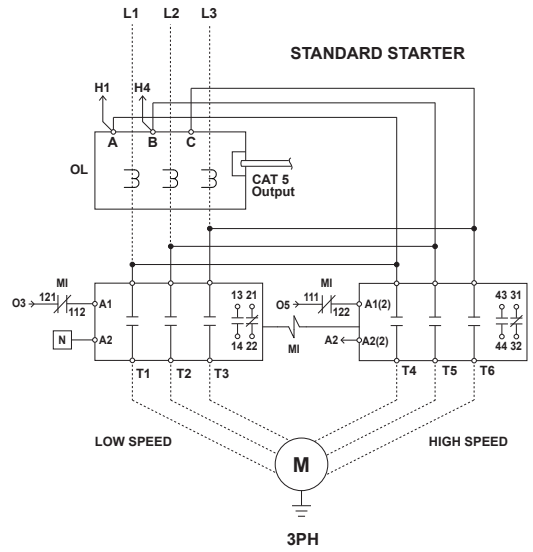
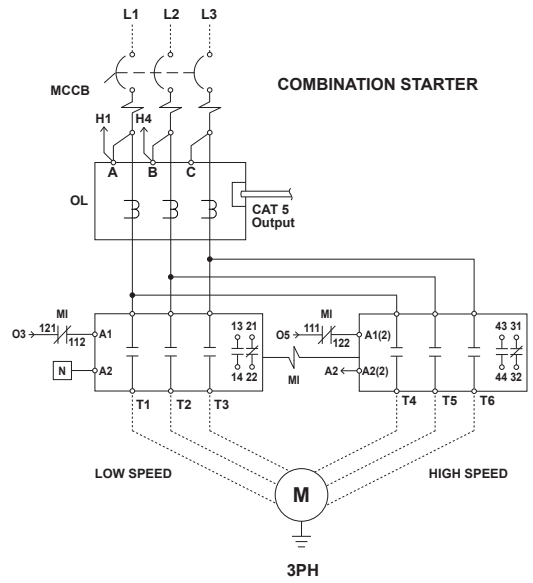
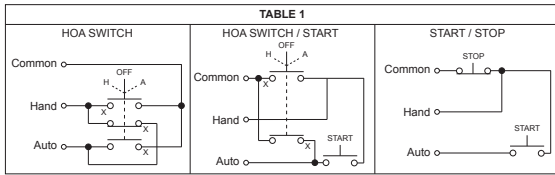
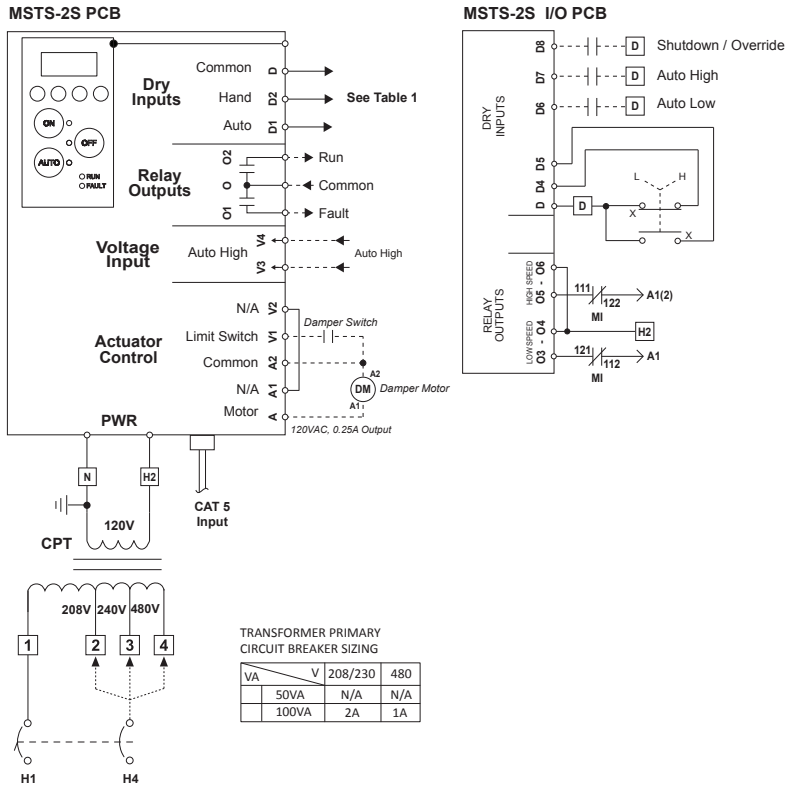

SCHM-MSTS-2S-V2

4) Operation

Each function of SCM controlled starters is accessible through the keypad (shown below).

Hand Mode - Depressing the Hand button on the keypad operates the motor starter. The Red LED adjacent to the Hand button indicates Hand Mode is selected. The Green Run LED indicates proof of flow.

Automatic Mode - Depressing the Auto button on the keypad enables the control inputs to operate the motor starter. The Red LED adjacent to the Auto button indicates the Automatic mode is selected. The Green Run LED indicates proof of flow when the control inputs are commanded.

Run LED (green) - LED will be on if contactor coil is energized and there is proof of flow. (LED will blink if run has been commanded and there is no proof of flow)

Fault LED (red)- When the starter is in a fault condition, the red fault LED is on and the mode selected (Hand, Off or Auto) LED will be blinking. (LED will blink if current is above FLA)

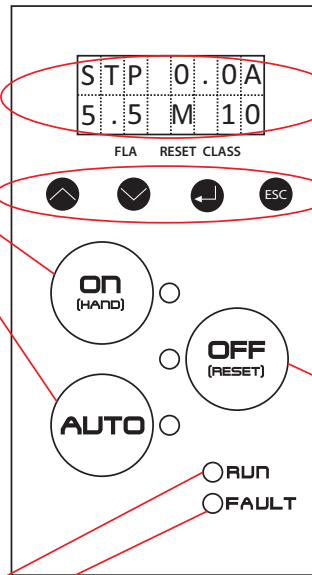

Default Screen

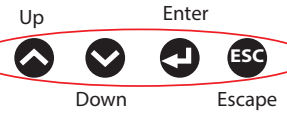

OFF/RESET - The motor starter is off when this button on the keypad is selected. The Green LED adjacent to the Off button indicates this mode is selected and the Run LED should be off. To reset, press the OFF button.

SCM KEYPAD

Lockout Feature

If adjustments need to be made to the overload, ground fault (optional), HP, or voltage settings, they must first be unlocked. Follow the steps below to unlock the settings.

- 1)

S	T	P	0	.	0	A
5	.	5	M	1	0	

 +  Press and Hold for 2 Seconds

Press and hold the up and down buttons on the keypad for 2 seconds, or until the screen matches the figure below

S	E	T	T	I	N	G	S
L	O	C	K	E	D		◀

- 2)

S	E	T	T	I	N	G	S
L	O	C	K	E	D		◀

 + 

Press the enter button on the keypad to change the menu from “locked” to “unlocked”, then press escape

S	E	T	T	I	N	G	S
U	N	L	C	K	D		◀

 + 

The lockout feature should now be disabled. Press the escape key to return to the default display screen. Adjustments may now be made to the overload FLA setting and ground fault level setting. The lockout feature will automatically re-enable itself after 2 minutes.

Advanced Settings

Unlocking the advanced settings menu will allow the user to cycle through the complete list of motor protection functions and settings. Follow the steps below to unlock the advanced settings menu.

- 1)

S	T	P	0	.	0	A
5	.	5	M	1	0	

 +  Press and Hold for 8 Seconds

Press and hold the up and down buttons on the keypad for 8 seconds, or until the screen matches the figure below.

A	D	V	S	E	T		
L	O	C	K	E	D		◀

- 2)

A	D	V	S	E	T		
L	O	C	K	E	D		◀

 + 

Press the enter button on the keypad to change the menu from “locked” to “unlocked”.

A	D	V	S	E	T		
U	N	L	C	K	D		◀

 + 

The lockout feature should now be disabled. Press the escape key to return to the default display screen.

The advanced settings menu is now accessible by pressing the enter button on the keypad when the default screen is displayed. Use the up and down keys to cycle through the various features of the starter. Press the escape key to return to the default display screen. The lockout feature will automatically re-enable itself after 2 minutes.

Setting Adjustments

The up and down keys will allow the user to scroll through the following. Press the escape key to return to the previous screen. In order to make adjustments to the overload, ground fault (optional), HP, or voltage settings, the Lockout Feature must be disabled (see page 15). In order to access the complete list of motor protection functions, the Advanced Settings Menu must be unlocked (see page 15).

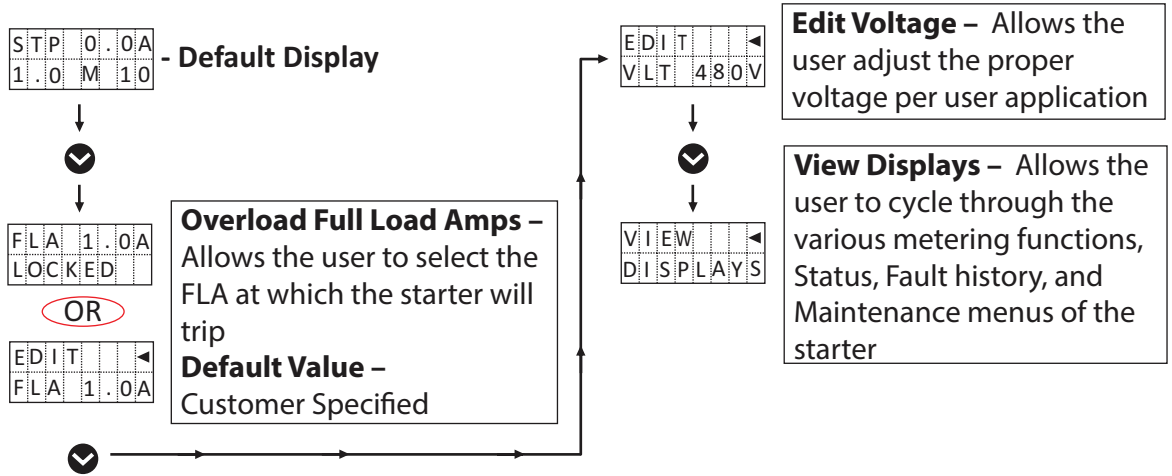

Once the Lockout Feature is disabled, follow the example below to make adjustments to the overload FLA or ground fault current level settings if desired.

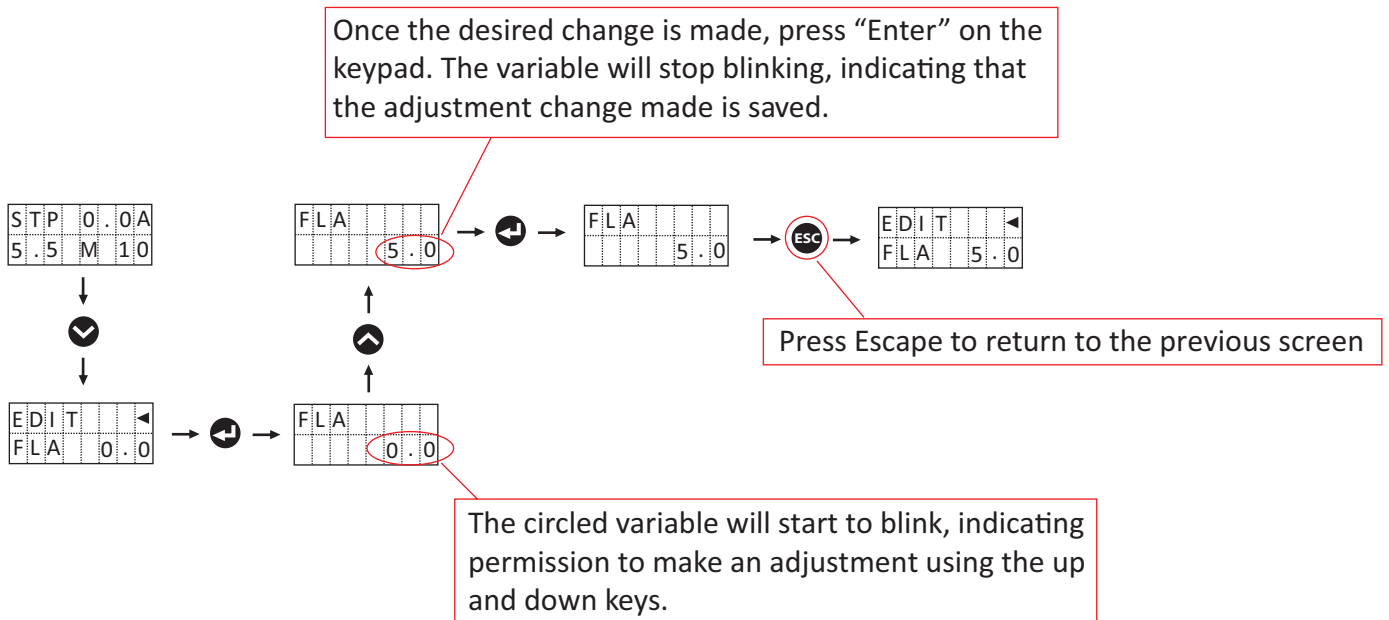

Advanced Settings Menu Structure

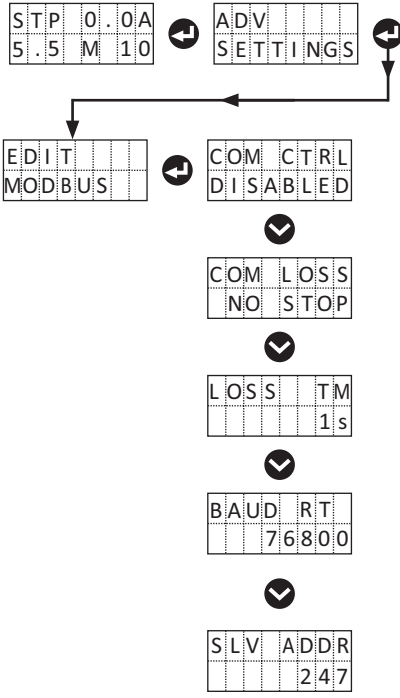
	Applicable Starter	Adjustment	Description
EDIT MODBUS	MSEM - OPT	Enabled/ Disabled	<ul style="list-style-type: none"> Communication Control: Disables/enables control (i.e. write commands) via modbus. Communications (i.e. read commands) are always enabled Default = Disabled
COM LOSS NO STOP	MSEM - OPT	Stop/ No Stop	<ul style="list-style-type: none"> In the event of a loss in Modbus communications, the user may select if the starter shall continue to run or stop. Default = No Stop
LOSS TM 1s	MSEM - OPT	1-120 Seconds	<ul style="list-style-type: none"> Loss TM detects receipt of any Read-Property or Write-Property request. When received, resets a running counter which is checked against the COM LOSS parameter. Default = 1 second
BAUD RT 76800	MSEM - OPT	9600,19200, 38400,76800	<ul style="list-style-type: none"> Baud Rate allows the user to select the desired Baud Rate. Default = 76800
SLV ADDR 247	MSEM - OPT	1-247	<ul style="list-style-type: none"> Slave Address: The address of Modbus requests that the starter will respond to Default = 247





























Advanced Settings Menu Structure Continued...

	Applicable Starter	Adjustment	Description
	STD - ALL	ON / OFF	<p>Backspin Delay: Minimum delay between a stop and the next allowed start; Backspin delay prevents rapid attempts at restarting.</p> <ul style="list-style-type: none"> The Backspin Delay feature is disabled when OFF. Default = OFF Delay time is the minimum delay between stop and the next allowed start. Default = 30 sec.
	STD - ALL	ON / OFF	<p>On Delay: Delay from start commanded until motor started.</p> <ul style="list-style-type: none"> The On Delay feature is disabled when OFF. Default = OFF Delay time is the minimum delay from start command until motor started. Default = 30 sec.
	STD - ALL	Auto / Permissive Auto	<ul style="list-style-type: none"> Dry Input 1 allows the user to define Input 1 as either Auto Run or Permissive Auto. Default = Auto run Dry Input 2 allows the user to define Input 2 as either Shutdown or PermissiveAuto. Default = Shutdown Dry Input 3: Programmable NO or NC contact. Acts as an auto run command to the starter by default. Default = NO Dry Input 4: Programmable NO or NC contact. No action by default. Default = NO
	STD - ALL	Shutdown / Permissive Auto	
	MSEM - OPT	NO / NC	
	MSEM - OPT	NO / NC	
	STD - ALL	1% - 100%	<p>Outputs: Status Relay is closed when the motor is running in a loaded condition at the user selected percentage limit threshold over .5 seconds. Default = 20%</p>
	STD - ALL	LOCKED/ UNLOCKED	<p>HOA Keys: Allows the user to lock or unlock the use of the HOA keys on the SCM keypad. Default = Unlocked</p>
	STD - ALL	ON / OFF	<p>Cycle Fault: Trips when an unusually high amount of motor starts and stops are detected. (rate > 20/min) Default = ON</p>
	STD - ALL	OFF, LAST, ADVANCED	<p>Power Fail Modes: Allows the user to select the return mode of the starter in the event of a power failure. Advanced will return the starter to the off state if the power failure is > 2 seconds. Default = Last</p>

Advanced Settings Menu Structure Continued...

	Applicable Starter	Adjustment	Description
	STD - ALL	120V, 208V, 240V, 277V, 480V, 600V	<ul style="list-style-type: none"> Allows the user to select the nominal voltage per user application. Default = Factory Setting
	OPT	ON / OFF	<p>OV/UV: Trips when the measured voltage is over or under the nominal voltage.</p> <ul style="list-style-type: none"> Trip is disabled when OFF. Alarm is still displayed. Default = OFF
	OPT	± 5% - 25%	<ul style="list-style-type: none"> Level is the % Level over or under the nominal voltage, at which OV/UV Trip occurs. Default = 15%
	OPT	0 - 99 Seconds	<ul style="list-style-type: none"> Trip Delay time is the minimum delay between stop and the next allowed start in the event of an OV/UV Trip. Default = 10 sec.
	OPT	Manual/ Auto	<ul style="list-style-type: none"> Reset allows the user to select between manual and automatic reset of the starter in the event of an OV/UV trip. Default = Manual
	OPT	0-5	<ul style="list-style-type: none"> Retries allows the user to select the maximum number of reset retries the SCM will attempt in the event of an OV/UV trip. Default = 3 retries
	OPT	5 - 9999 Seconds	<ul style="list-style-type: none"> Reset delay allows the user to select the time between reset retries in the even of an OV/UV trip. Default = 300 seconds
	STD - ALL	1% - 50%	<p>Voltage Phase Loss: A trip will occur when the percentage of deviation between any one phase and the average voltage is greater than the selected % level. Applies to 3-phase only. Default = 5%</p>
	STD - ALL	ON / OFF	<p>Voltage Phase Unbalance: A trip will occur when there is a voltage unbalance on all three phases.</p> <ul style="list-style-type: none"> Trip is disabled when OFF. Alarm is still displayed. Default = OFF
	STD - ALL	1% - 50%	<ul style="list-style-type: none"> Trip will occur when the percentage of deviation between any one phase and the average voltage is greater than the selected % level. Default = 5%
	STD - ALL	ON / OFF	<p>Reverse Phase: Trips when voltage phase sequence is reversed.</p> <ul style="list-style-type: none"> Trip is disabled when OFF. Alarm is still displayed. Default = OFF
	MSEM Only	1 or 3 Phase	<p># of Phases: The MSEM is capable of controlling 1 or 3 phase motors. Default = Factory</p>

Advanced Settings Menu Structure Continued...

<div style="border: 1px solid black; padding: 2px; display: inline-block;">EDIT</div> <div style="border: 1px solid black; padding: 2px; display: inline-block;">VOLTAGE</div>  <div style="border: 1px solid black; padding: 2px; display: inline-block;">EDIT</div> <div style="border: 1px solid black; padding: 2px; display: inline-block;">CURRENT</div>  See Next Page	Applicable Starter	Adjustment	Description
<div style="border: 1px solid black; padding: 2px; display: inline-block;">EDIT</div> <div style="border: 1px solid black; padding: 2px; display: inline-block;">OVERLOAD</div>  <div style="border: 1px solid black; padding: 2px; display: inline-block;">FLA</div> <div style="border: 1px solid black; padding: 2px; display: inline-block;">1.0A</div> 	STD - ALL	Differs per model	Overload: Trips according to trip curve in Appendix A. <ul style="list-style-type: none"> FLA allows the user to select the appropriate full load amps obtained from the nameplate of the motor to be controlled. Default = Customer Specified
 <div style="border: 1px solid black; padding: 2px; display: inline-block;">CLASS</div> <div style="border: 1px solid black; padding: 2px; display: inline-block;">10</div> 	STD - ALL	5 - 30	<ul style="list-style-type: none"> Trip Class allows the user to select the trip class, obtained from the nameplate of the motor to be controlled. Default = 10
 <div style="border: 1px solid black; padding: 2px; display: inline-block;">SVC FCTR</div> <div style="border: 1px solid black; padding: 2px; display: inline-block;">1.0</div> 	STD - ALL	1.0 - 2.0	<ul style="list-style-type: none"> Service factor is the FLA multiplier used to increase the time of the overload trip. See motor nameplate Default = 1.15
 <div style="border: 1px solid black; padding: 2px; display: inline-block;">RESET</div> <div style="border: 1px solid black; padding: 2px; display: inline-block;">MANUAL</div> 	STD - ALL	Manual / Auto	<ul style="list-style-type: none"> Reset allows the user to select between manual and automatic reset of the starter in the event of an overload trip. Default = Manual
 <div style="border: 1px solid black; padding: 2px; display: inline-block;">RETRIES</div> <div style="border: 1px solid black; padding: 2px; display: inline-block;">3</div> 	STD - ALL	0 - 5	<ul style="list-style-type: none"> Retries allows the user to select the maximum number of reset retries the SCM will attempt in the event of an overload trip. Default = 3
 <div style="border: 1px solid black; padding: 2px; display: inline-block;">RST DELAY</div> <div style="border: 1px solid black; padding: 2px; display: inline-block;">300s</div> 	STD - ALL	5 - 9999 Seconds	<ul style="list-style-type: none"> Reset delay allows the user to select the time between reset retries in the event of an overload trip. Default = 300 seconds
 <div style="border: 1px solid black; padding: 2px; display: inline-block;">COOLDOWN</div> <div style="border: 1px solid black; padding: 2px; display: inline-block;">ON</div> 	STD - ALL	ON / OFF	<ul style="list-style-type: none"> Cooldown prevents the motor from starting for 3 minutes in the event of an overload condition. Default = ON
 <div style="border: 1px solid black; padding: 2px; display: inline-block;">LCKD RTR</div> <div style="border: 1px solid black; padding: 2px; display: inline-block;">ON</div> 	STD - ALL	ON / OFF	<ul style="list-style-type: none"> Locked rotor trip is disabled when OFF. Alarm is still displayed. Default = ON
 <div style="border: 1px solid black; padding: 2px; display: inline-block;">OUT OF CAL</div> <div style="border: 1px solid black; padding: 2px; display: inline-block;">ON</div> 	MSEM	ON / OFF	<ul style="list-style-type: none"> Prevents setting the overload FLA too high. Fault occurs if the measured inrush current is not between 400% and 1400% of FLA Default = ON
 <div style="border: 1px solid black; padding: 2px; display: inline-block;">MAX TIME</div> <div style="border: 1px solid black; padding: 2px; display: inline-block;">ON</div> 	MSEM	ON / OFF	<ul style="list-style-type: none"> Fault will occur if after starter is running for 10 seconds with the current above 200% of FLA and decreasing Default = ON
<div style="border: 1px solid black; padding: 2px; display: inline-block;">EDIT</div> <div style="border: 1px solid black; padding: 2px; display: inline-block;">GND FLT</div>  <div style="border: 1px solid black; padding: 2px; display: inline-block;">TRIP</div> <div style="border: 1px solid black; padding: 2px; display: inline-block;">ON</div> 	OPT	ON / OFF	Ground Fault: Trips according to trip curve in Appendix A. Trips when there is a leakage of current to the ground, greater than the amperage level. <ul style="list-style-type: none"> Trip is disabled when OFF. Alarm is still displayed. Default = ON
 <div style="border: 1px solid black; padding: 2px; display: inline-block;">LEVEL</div> <div style="border: 1px solid black; padding: 2px; display: inline-block;">1A</div> 	STD - ALL	1A - 9.9A	<ul style="list-style-type: none"> Level allows the user to select the amperage level at which a ground fault trip will occur. Default = 1A
<div style="border: 1px solid black; padding: 2px; display: inline-block;">EDIT</div> <div style="border: 1px solid black; padding: 2px; display: inline-block;">CUR UNBL</div>  <div style="border: 1px solid black; padding: 2px; display: inline-block;">TRIP</div> <div style="border: 1px solid black; padding: 2px; display: inline-block;">OFF</div> 	STD - ALL	ON / OFF	Current Unbalance: Trips when there is a current unbalance on all three phases <ul style="list-style-type: none"> Trip is disabled when OFF. Alarm is still displayed. Default = OFF
 <div style="border: 1px solid black; padding: 2px; display: inline-block;">LEVEL</div> <div style="border: 1px solid black; padding: 2px; display: inline-block;">20%</div>	STD - ALL	5% - 50%	<ul style="list-style-type: none"> Level % allows the user to select the percentage of deviation between any one phase and the average current, at which point, the SCM will trip. Default = 20%

Advanced Settings Menu Structure Continued...

	Applicable Starter	Adjustment	Description
	OPT	ON / OFF	Under Power: Trips when the measured horsepower is less than the nominal horsepower <ul style="list-style-type: none"> • Trip is disabled when OFF. Alarm is still displayed. Default = OFF
	OPT	0% - 99%	<ul style="list-style-type: none"> • Level % allows the user to select the % level of nominal HP, at which trip occurs. Default = 50%
	OPT	0.125 - 1000	<ul style="list-style-type: none"> • Nominal HP should be set to the nominal HP of the motor the SCM is to control. Default = Factory Setting
	OPT	0 - 99 Seconds	<ul style="list-style-type: none"> • Trip Delay time is the minimum delay between stop and the next allowed start in the event of an under power Trip. Default = 10 sec.
	OPT	Manual / Auto / Well Recovery	<ul style="list-style-type: none"> • Reset allows the user to select between manual and automatic reset of the starter in the event of an under power trip. Well recovery will allow the user to reset an infinite number of times, based on a time delay of up to 48hrs. Default = Manual
	OPT	0 - 5	<ul style="list-style-type: none"> • Retries allows the user to select the maximum number of reset retries the SCM will attempt in the event of an under power trip. Default = 3
	OPT	5 - 9999 Seconds	<ul style="list-style-type: none"> • Reset delay allows the user to select the time between reset retries in the even of an under power trip. Default = 300 seconds
	OPT	ON / OFF	Over Power: Trips when the measured horsepower is greater than the nominal horsepower <ul style="list-style-type: none"> • Trip is disabled when OFF. Alarm is still displayed. Default = OFF
	OPT	101% - 200%	<ul style="list-style-type: none"> • Level % allows the user to select the % level of nominal HP, at which trip occurs. Default = 120%
	OPT	0.125 - 1000	<ul style="list-style-type: none"> • Nominal HP should be set to the nominal HP of the motor the SCM is to control. Default = Factory Setting
	OPT	0 - 99 Seconds	<ul style="list-style-type: none"> • Trip Delay time is the minimum delay between stop and the next allowed start in the event of an over power Trip. Default = 10 sec.
	OPT	Manual/ Auto	<ul style="list-style-type: none"> • Reset allows the user to select between manual and automatic reset of the starter in the event of an over power trip. Default = Manual
	OPT	0 - 5	<ul style="list-style-type: none"> • Retries allows the user to select the maximum number of reset retries the SCM will attempt in the event of an over power trip. Default = 3 retries
	OPT	5 - 9999 Seconds	<ul style="list-style-type: none"> • Reset delay allows the user to select the time between reset retries in the even of an over power trip. Default = 300 seconds

Advanced Settings Menu Structure Continued...

<pre> EDIT POWER </pre>	Feature	Adjustment	Description
<pre> ↓ EDIT RESETS </pre>	STD - ALL	NO / YES	<u>kWh Reset</u> <ul style="list-style-type: none"> Resets the SCM kWh clock.
<pre> ↓ RESET kWh </pre>	STD - ALL	NO / YES	<u>kW Runtime Reset</u> <ul style="list-style-type: none"> Resets the SCM kW runtime clock.
<pre> ↓ RESET kW RUNTM </pre>	STD - ALL	NO / YES	<u>Fault Count Reset</u> <ul style="list-style-type: none"> Resets the SCM fault count.
<pre> ↓ RST FLT RESETCNT </pre>	STD - ALL	NO / YES	<u>Power Loss Count Reset</u> <ul style="list-style-type: none"> Resets the SCM power loss count.
<pre> ↓ RST PWR LOSS CNT </pre>	STD - ALL	NO / YES	<u>Fault History Reset</u> <ul style="list-style-type: none"> Resets the fault history.
<pre> ↓ RST FLT HISTORY </pre>	STD - ALL	NO / YES	<u>Contactor</u> <ul style="list-style-type: none"> Displays the contactor FLA of the SCM starter.
<pre> ↓ EDIT HARDWARE </pre>	STD - ALL	9A - 1520A (Read Only)	<u>CT Ratio</u> <ul style="list-style-type: none"> Displays the CT Ratio when the SCM starter is needed to operate motors that require > 95A

Display Features

To view the display features of the SCM, follow the steps below using the keypad.

S	T	P	0	.	0	A
5	.	5	M	1	0	

(Default Display Screen)

⏴ x5

V	I	E	W				
D	I	S	P	L	A	Y	S

⏴

V	I	E	W				
M	E	T	E	R	I	N	G

⏴

V	I	E	W			
V	O	L	T	A	G	E

⏴

DISPLAY (Read Only)	
Average Voltage	C-A Voltage
A-B Voltage	Line-Neutral Voltage
B-C Voltage	Frequency

⏴

↓

V	I	E	W			
C	U	R	R	E	N	T

⏴

Maximum Current	Estimated Trip Time
Phase A Current	Estimated Cooldown Time
Phase B Current	CT Ratio
Phase C Current	Ground Current

⏴

⏴

↓

V	I	E	W	
P	O	W	E	R

⏴

Kilowatts	Power Factor
Kilovolt-Amperes	Kilowatt Hours
Kilovolt-Ampere-Reactance	Power Loss Count

⏴

⏴

V	I	E	W		
S	T	A	T	U	S

⏴

V	I	E	W		
I	N	P	U	T	S

⏴

Auto Run / Permissive Auto / Shutdown Input	Dry Input 4 (Modbus only)
Fireman's Override	Communications (MSEM-Optional)
Dry Input 3 (Modbus only)	

See Next Page

V	I	E	W			
O	U	T	P	U	T	S

⏴

FAULT / RUN / STATUS

⏴

See Next Page

Display Features Continued

VIEW OUTPUTS	▼	DISPLAY (Read Only)								
VIEW OPT BRD	▶	Views installed option board								
VIEW kW RUN TIME	▶	<table border="1"> <tr> <td>kW Runtime (years-months)</td> <td>kW Runtime (minutes-seconds)</td> </tr> <tr> <td>kW Runtime (days-hours)</td> <td></td> </tr> </table>	kW Runtime (years-months)	kW Runtime (minutes-seconds)	kW Runtime (days-hours)					
kW Runtime (years-months)	kW Runtime (minutes-seconds)									
kW Runtime (days-hours)										
VIEW SYS TIME	▶	<table border="1"> <tr> <td>System Time (years-months)</td> <td>System Time (minutes-seconds)</td> </tr> <tr> <td>System Time (days-hours)</td> <td></td> </tr> </table>	System Time (years-months)	System Time (minutes-seconds)	System Time (days-hours)					
System Time (years-months)	System Time (minutes-seconds)									
System Time (days-hours)										
VIEW FAULTS	▶	VIEW FLT HIST								
	▶	Faults 1-15								
	▼									
	▶	VIEW RESETCNT								
	▶	Reset Count								
	▼									
	▶	VIEW FAULTCNT								
	▶	Displays fault count of each type (up to 255 faults)								
ADMIN	▶	VIEW IP ADDR								
	▶	IP Address 1								
	▶	IP Address 2								
	▼									
	▶	S/W VER'S 7.005								
	▶	Software Version								
	▼									
	▶	OPT VER'S 1.02								
	▶	Option board firmware revision number (If applicable).								
	▼									
	▶	SERIAL # 09094567								
	▶	Serial #								
	▼									
	▶	VIEW OPTIONS								
	▶	<table border="1"> <tr> <td>Application (MSEM)</td> <td>Option 4</td> </tr> <tr> <td>Option 1</td> <td>Option 5</td> </tr> <tr> <td>Option 2</td> <td>Option 6</td> </tr> <tr> <td>Option 3</td> <td></td> </tr> </table>	Application (MSEM)	Option 4	Option 1	Option 5	Option 2	Option 6	Option 3	
Application (MSEM)	Option 4									
Option 1	Option 5									
Option 2	Option 6									
Option 3										

Fault and Alarm Descriptions

A fault condition will stop motor operation and prohibit starting if its protective function is enabled. Alarm conditions will not prevent operation. An alarm may still be displayed even if the fault trip has been disabled. In order to reset a fault, press the OFF key for 5 seconds.

Alarm / Fault	Display Text	Type	Description
Locked Rotor	LOCK RTR	Fault	Locked Rotor Fault will occur after 0.5 seconds any time a locked rotor condition is detected. Locked rotor is defined as the measured current being over 300% of FLA and not decreasing over a period of 0.5 seconds.
Overload	OVERLOAD	Fault	Overload Fault depends on the measured current, FLA setting, trip class, and service factor. The time to trip is based on the inverse trip curves in Appendix A.
Voltage Phase Unbalance	VPH UNBL	Fault / Alarm	Voltage Phase Unbalance Fault will occur if any phase voltage is above or below the average voltage by more than the user set level, for the duration of the user set time period.
Voltage Phase Loss	VPH LOSS	Fault	Voltage Phase Loss Fault will occur if any phase voltage is below the average voltage by more than the user set level, for the duration of the user set time period. Cannot be disabled.
Current Phase Unbalance	CPH UNBAL	Fault / Alarm	Current Phase Unbalance Fault will occur if any of the measured phase currents deviates from the average current by more than the user set level, for the duration of the user set time period.
Over Voltage	OVR VOLT	Fault / Alarm	Over Voltage Fault will occur if the average voltage exceeds the nominal voltage by more than the programmed percentage.
Under Voltage	UND VOLT	Fault / Alarm	Under Voltage Fault will occur if the average voltage is below the nominal voltage by more than the programmed percentage.
Cycle Fault	CYC FLT	Fault	Cycle Fault is caused by excessive closure of the contactor. If the closure rate exceeds 20/minute the starter will fault (minimum of 6 closures).
Ground Fault	GND FLT	Fault	Ground Fault is based on the vector sum of the phase currents. Inverse trip curves are provided in Appendix A. Test procedures per UL 1053 are provided in Appendix B. For starter sizes S4 and above, it is suggested that this feature be disabled.
Reverse Phase	REV PHSE	Fault	Reverse Phase Fault will occur if the input voltage phase sequence is measured to be reversed from the default phase ordering sequence.
Under Power	UNDERPOWR	Fault / Alarm	Under Power Fault will occur if the motors measured output power is below the programmed threshold level percentage multiplied by the Nominal HP setting. Protects motors from belt loss damage.
Over Power	OVERPOWR	Fault / Alarm	Over Power Fault will occur if the motors measured output power is above the programmed threshold level percentage multiplied by the Nominal HP setting.

Alarm / Fault	Display Text	Type	Description
Contactor Issue	CONTACTOR	Alarm	Contactor Alarm appears when the SCM fails to detect current for 2 minutes after a run command occurs. Indicates that the contactor has failed or become detached.
Current Flow Issue	FLOW	Alarm	Flow Alarm appears when the SCM detects current when the starter is not given a run command.
Keypad Issue	KEYPAD	Alarm	Keypad Alarm indicates that the keypad has become detached or damaged.
Meter Base Detached	NO BASE	Fault / Alarm	No Meter Base Alarm is caused when the SCM meter base is detached or damaged. The SCM cannot receive current and voltage data to provide motor protection and metering.
Option Board Issue	OPT BRD	Fault / Alarm	Option Board Alarm occurs when the installed option board becomes detached. It can also indicate if an option board necessary for operation isn't installed.
Communications Loss	LOSSCOMMS	Fault / Alarm	Communications Loss Fault indicates that the loss of timer has expired. The timer is reset every time an external communication event occurs. Modbus option board only. Enabled by setting COMM LOSS to STOP.
Out Of Calibration	OUTOFCAL	Fault	Out of Calibration Fault provides a rough check that the system has been setup properly. The fault occurs if the measured inrush current is not between 400% and 1400% of FLA.
Max Time to Start	MAX TIME	Fault	Max Time to Start Fault indicates a slow motor start or excessive load. The fault is triggered if after running for 10 seconds the current is above 200% of FLA and decreasing.

Appendix A - Overload and Ground Fault Trip Curves

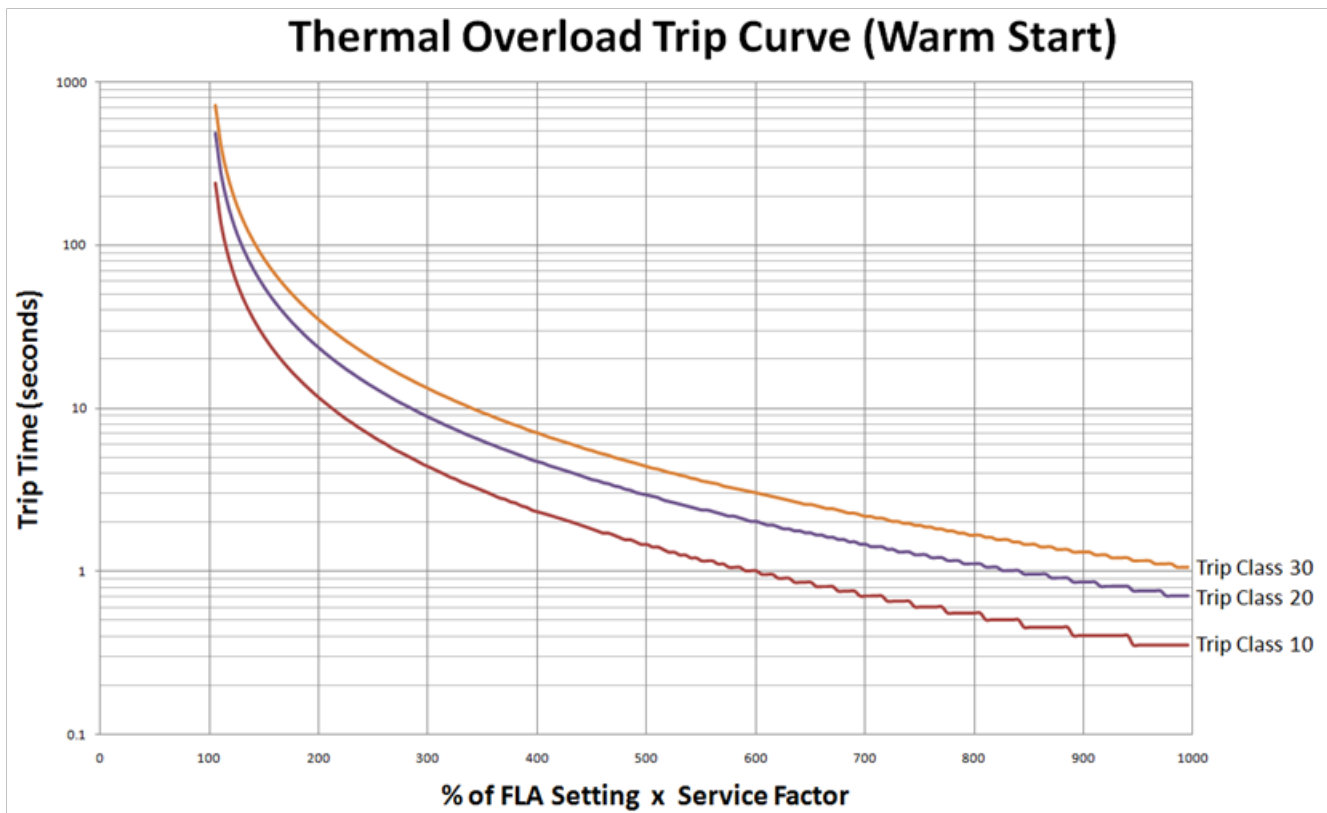
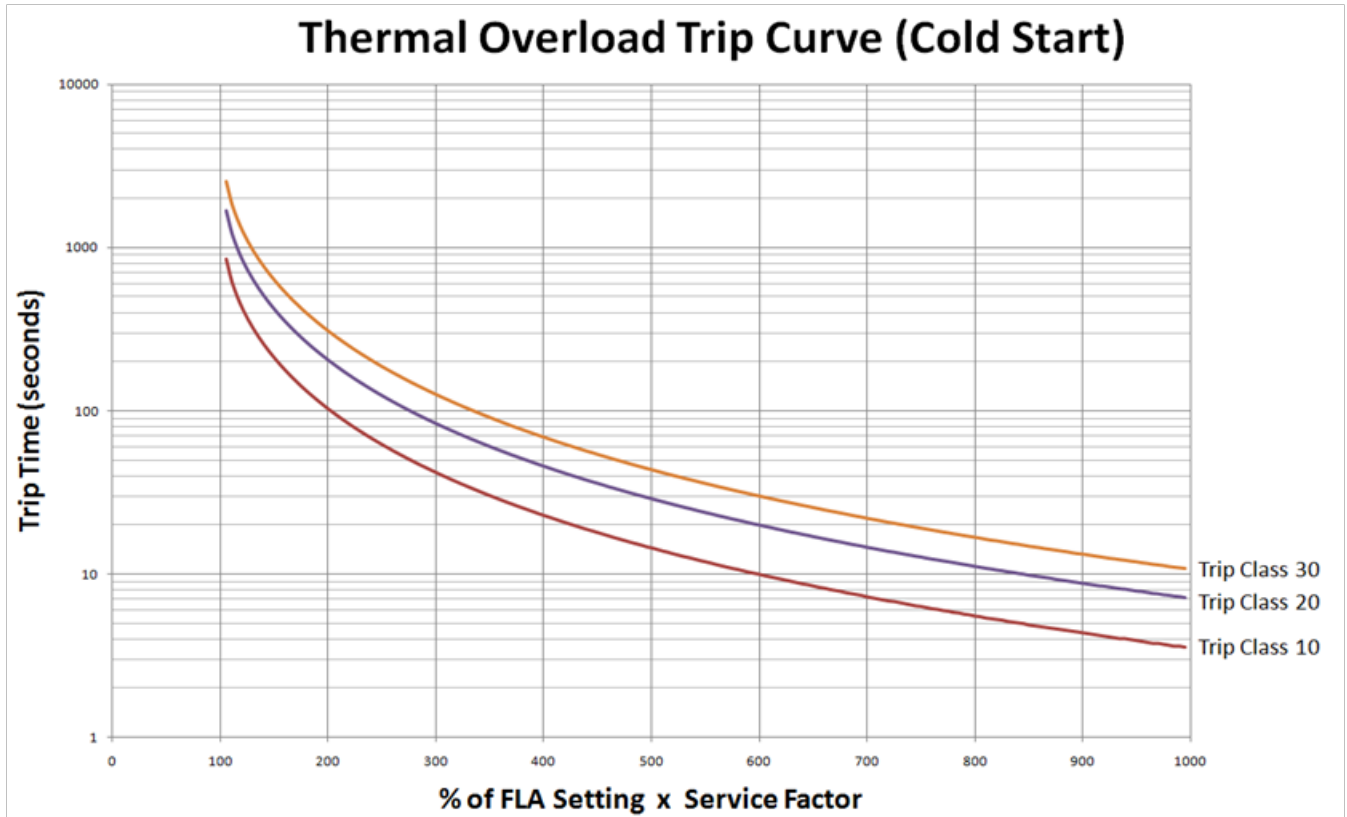

Ground Fault Trip Curve

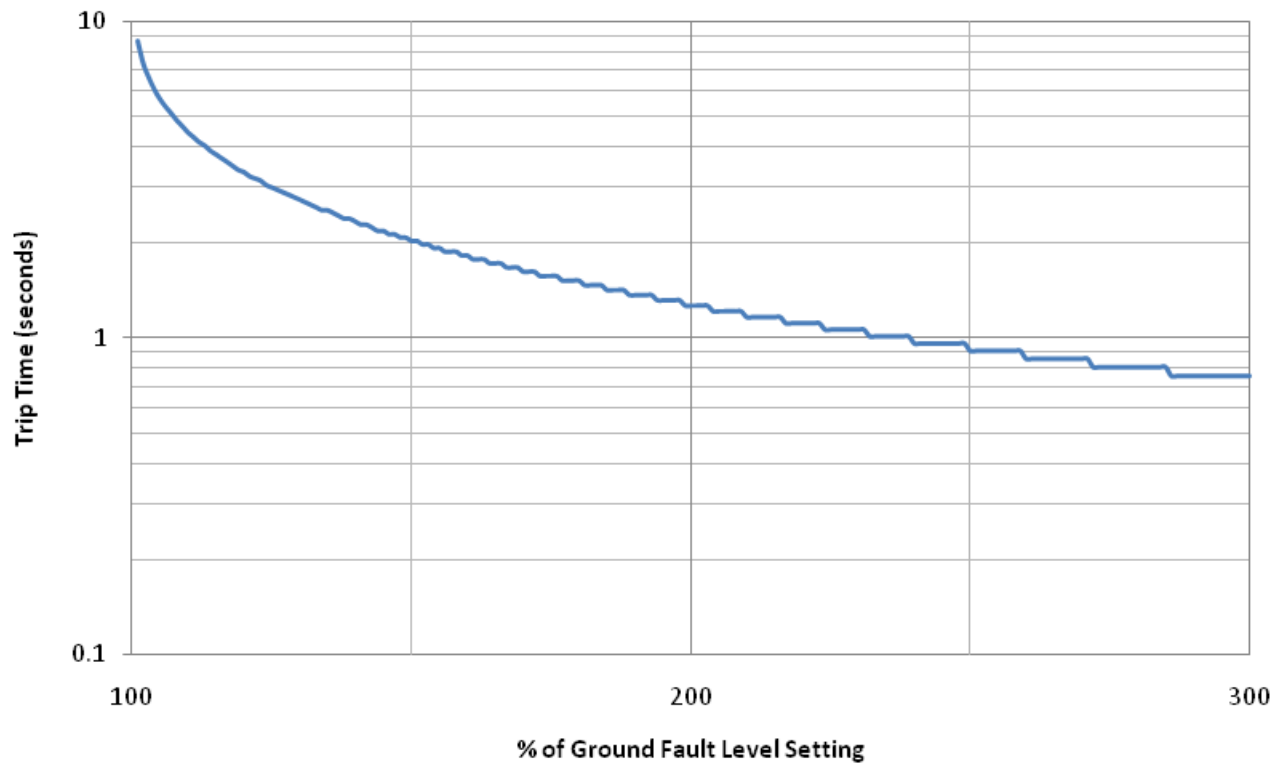

Appendix B - Ground Fault Testing Procedure

- 1) Disconnect Power.
- 2) Connect the three line voltages to terminals R(L1), S(L2), T(L3) on the contactor.
(MCP disconnect or MCCB if this is a combination starter)
- 3) Apply power to starter.
- 4) For test purposed, turn Ground Fault Trip "ON", and set the Ground Fault Level to "1.0A".
- 5) Using an AC power supply, construct the circuit below. This circuit simulates a ground fault condition by generating a current in one of the phases. Alternate test circuits may be used. The only requirement is the current through the current transformer must be at least 115% of the ground fault setting and pass through only one CT window.

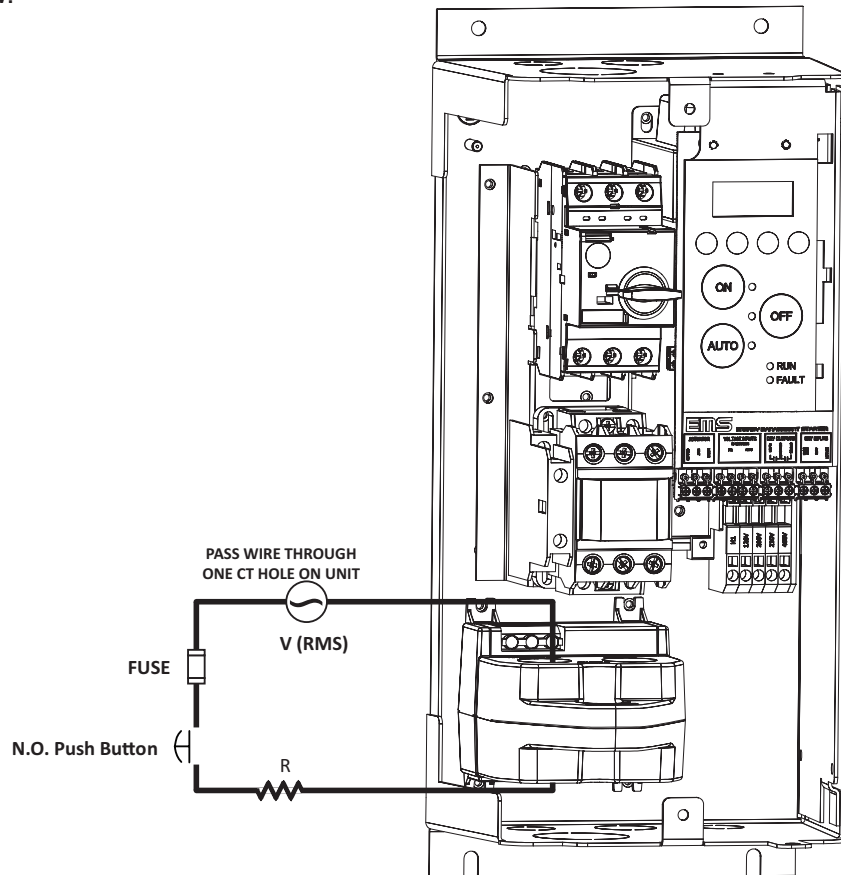

- 6) The values of V and R will be determined by the current required to generate a ground fault trip condition:
 $I = V_{rms}/R$, where $I = 115\%$ of ground fault setting.
- 7) Place the unit in "Hand" mode, apply three phase power, and allow the contactor to close.
- 8) Energize the test circuit by pushing and holding the "N.O. Push Button" until the unit trips. The SCM Display should show a Ground Fault alarm and the N.O. contacts should be open. Release the "N.O. Push Button".

Ground Fault Test Results

Date: _____
 Performed By: _____
 Trip (Y/N) _____
 Location: _____

*Form should be retained by the building's electrical foreman

Appendix C - MSEM Option Boards

Ethernet I/O (Fault Logging) Option Board

Ethernet Connections

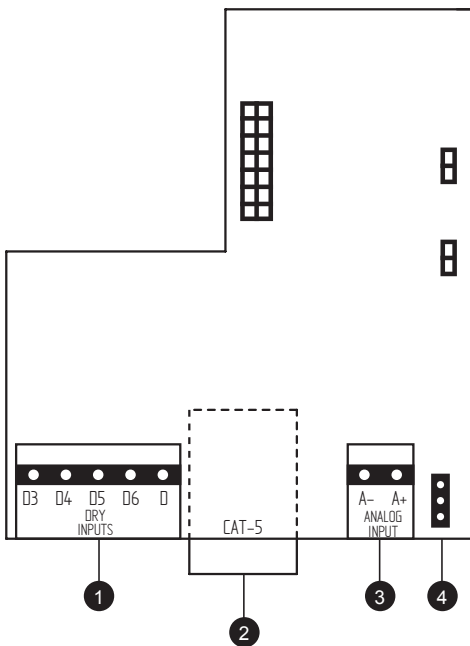

- 1 Dry Contact Inputs
- 2 Ethernet Cable Connection
- 3 Analog Input
- 4 Analog Input Selector Jumper

Dry Contact Inputs	Dry input terminals. Normally open contacts or transistorized inputs.
Ethernet Cable Connection	CAT-5 Cable with RJ-45 Connection
Analog Input	Analog input for 4-20mA, 0-10V or 10KΩ thermistor.
Analog Input Selector Jumper	No Jumper: 0-10V Input Jumper Pin 1 & 2: 10KΩ Thermistor Input Jumper Pin 2 & 3: 4-20mA Input

Ethernet Setup

Establishing Ethernet Connection

- Turn off and disconnect power to the starter
- Connect ethernet cable from the starter's CAT-5 terminal to one of the following:
 - 1) Personal computer (PC will assign IP address)
 - 2) Network (Router will assign IP address)
- After establishing connections, return power to the starter
- Obtain IP address by following the steps below:

Display Screens:

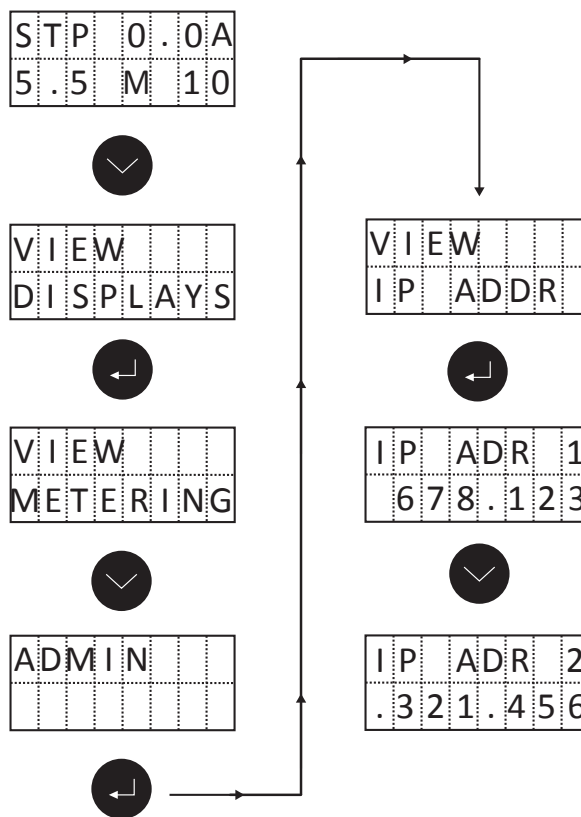

⚠ WARNING

- Replace battery with Renata SA, Part No. CR2032RV MFR only. Use of another battery may present a risk of fire or explosion. Contact Greenheck for replacement batteries.
- Battery may explode if mistreated. Do not recharge, disassemble or dispose of in fire.

- In web browser, type IP address (IP address = IP ADR 1 + IP ADR 2)
- After web page loads the user can set the location, description, date, time and view fault history

Tru-Power™ (Power Meter) Option Board

Tru-Power™ Outputs

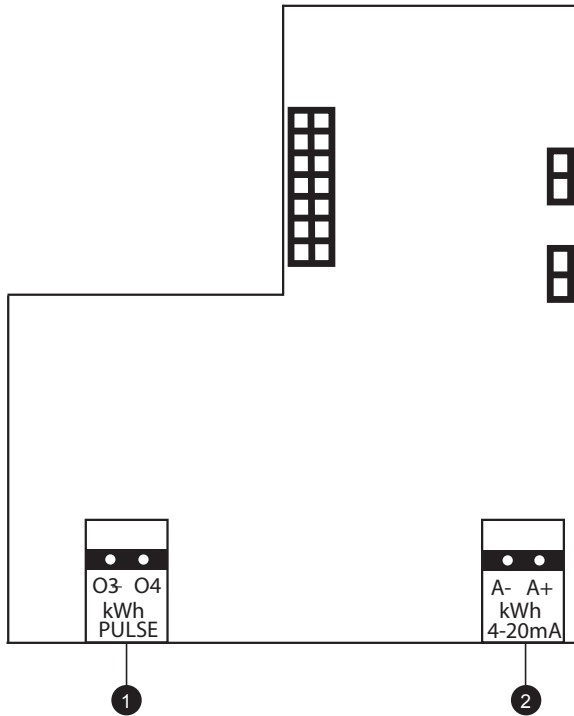

- 1 Digital Pulse Output
- 2 Analog Output

Digital Pulse Output	Solid state output that cycles based on EDIT kWh PULSE parameter settings (Select from 0.25, 0.5, 1, 2). Default setting is 1 kWh per pulse. Output contacts rated at 24 VAC/DC, 150 mA.
Analog Output	4~20 mA analog value for measured kW. 0 measured kW results in 4 mA. kW MAX parameter results in 20 mA. Maximum output rating is 24V, self-powered loop.

Tru-Power™ Parameter Setup

It may be necessary to adjust settings and configure the starter for proper Tru-Power operation. From the Default Display screen, access the parameters to begin setup.

```

ADV
SETTINGS
    
```



In order to edit the Tru-Power operational settings, the Advanced Settings Menu must first be unlocked.



Press ENTER to access the parameters and begin setup.

```

EDIT
POWER
    
```

Use the ARROW keys to access the EDIT POWER settings.



```

EDIT
kWh PULSE
    
```



```

kWh/PULS
          1
    
```



```

EDIT kW
4 - 20mA
    
```



```

kW MAX
  342 kW
    
```

Set the desired number of kWh per pulses and press ENTER.

Press ESC and use the down arrow to access EDIT kW parameter. Enter the desired output scaling of the 4~20 mA reference signal.

Note: Always set kW MAX parameter based on actual motor sizing. Default value of 342kW may deliver lower resolution in small motor applications. Programming the kW MAX parameter accurately ensures detailed kW consumption output. The analog scale follows the relationship below:

4 mA → 0 kW

20 mA → MAX kW

Proper parameter mapping of the MAX kW value will ensure accurate scaling.

BACnet Communications

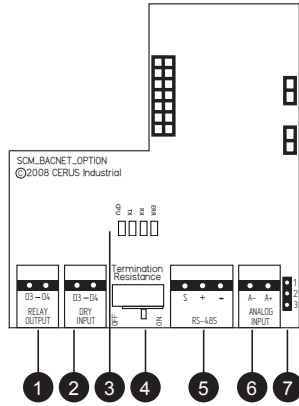

- 1 Relay Output
- 2 Dry Input
- 3 Status LEDs
- 4 Termination Resistance Switch
- 5 RS-485 Interface
- 6 Analog Input
- 7 Analog Input Selector Jumper

Relay Output (BV5)	Relay output contact rated for 0.3A @ 125VAC, 1A @ 24VDC.
Dry Input (BI10)	Dry input terminal. Normally open contact or transistorized input.
Status LEDs	<p>CPU (Green) <i>Flashing</i> - During normal operation, the CPU LED will blink in 1 second intervals. <i>Off</i> - BACnet board is not receiving power or potential board malfunction</p> <p>TX (Green) The TX LED will flash when the starter is transmitting data.</p> <p>RX (Green) The TX LED will flash when the starter is receiving data.</p> <p>ERR (Red) The ERR LED will flash if a data interruption occurs between the BACnet board and the starter's main control board. ERR LED will also flash if BACnet communications fail.</p>
Termination Resistance Switch	Select the ON position to enable termination resistor for RS-485 communication.
RS-485 Interface	Connect communication wiring using provided RS-485 terminals.
Analog Input (AI19)	Analog input for 4-20mA, 0-10V or 10KΩ thermistor.
Analog Input Selector Jumper	<p>No Jumper: 0-10V Input</p> <p>Jumper Pin 1 & 2: 10KΩ Thermistor Input</p> <p>Jumper Pin 2 & 3: 4-20mA Input</p>

BACnet Parameter Setup

It may be necessary to adjust settings and configure the starter for proper BACnet operation. From the Default Display screen, access the BACnet parameters to begin setup.

ADV
SETTINGS

In order to edit BACnet communication parameters, the Advanced Menu Settings must be unlocked



EDIT
BACNET

Press ENTER to access BACnet parameters and begin setup. Use the ARROW keys to navigate through parameters. Press ENTER to confirm your selections.



COM CTRL
DISABLED

Setting enables or disables communication via BACnet.



COM LOSS
NO STOP

In the event of a loss in BACnet communications, select if the starter should continue to RUN.



LOSS TM
30s

Detects receipt of any ReadProperty or WriteProperty request. When received, resets a running seconds counter which is checked against the COM LOSS parameter.



BAUD RT
76800

Adjust parameter to the desired Baud Rate 9600, 19200, 38400, or 76800.



DEV INST
223000

Assign an inter-network Device Instance to the starter. Select a unique identifier within a range of 1~4194302.



MAC ID
0

Set a unique Media Access Control (MAC) address. Each master device on the MS/TP daisy chain must have a unique MAC address (addressable range 0~127).



MAX MSTR
127

The Max Master parameter determines the maximum number of possible addresses assigned to the network.

Press ESC to return to the Default Display screen.

Modbus Option Board

Gate Drive Board	For soft starter use only
RS-485 (+ - S)	Connect Modbus wiring using provided RS-485 terminals.
Dry Inputs (D D3 D4)	Dry input terminals 3 and 4. N.O. or N.C. software configurable contact or transistorized input. D terminal is common.
Analog Input (A- A+)	Analog input for 4-20mA, 0-10V or 10K Ω thermistor.
Analog Input Selector Jumper	No Jumper: 0-10V Input Jumper Pin 1 & 2: 10K Ω Thermistor Input Jumper Pin 2 & 3: 4-20mA Input
Termination Resistance Switch (OFF ON)	Select the ON position to enable termination resistor for RS-485 communications.

Modbus Parameter Setup

It may be necessary to adjust settings to configure the starter for proper Modbus operation. From the Default Display screen, access the Comms parameters to begin setup. Please note the option board is designed to operate as a slave in Modbus RTU mode only. Serial communications should be set for 8 data bits, even parity and one stop bit.

Display Screen	Instruction / Description
ADV SETTINGS	Press and hold the UP and DOWN buttons for 8 seconds to unlock the Advanced Settings. Press the ENTER button to change the menu from "LOCKED" to "UNLOCKED."
EDIT MODBUS	Press ENTER to access Modbus parameters and begin setup. Use the ARROW keys to navigate through parameters. Press ENTER to confirm your selections.
COM CTRL DISABLED	Setting enables or disables starter control via Modbus.
COM LOSS NO STOP	In the event of a loss in Modbus communications, select if the starter should continue to Run, or Stop operation.
LOSS TM 30s	Detects receipt of any Modbus read or write request. When received, resets a running counter which is checked against the COM LOSS parameter.
BAUD RT 9600	Adjust parameter to the desired Baud Rate 9600, 19200, 34800, or 76800.
SLV ADDR 247	Adjust the slave address the Modbus option board responds to.

Press ESC to return to the Default Display screen.

Additional Dry Input

Applies to MSEM with the installation of the Modbus Option board.

- Operates in Auto mode only.
- Dry Inputs 3 and 4 are individually programmable N.O. or N.C.
- Dry Input 3 – Defaulted as a dry Auto Run input, can be configured to act as a Shutdown or Permissive Auto input
- Dry Input 4 – Does nothing by default

Appendix D - Warranty Information

Model Number	Starter Control Module	Warranty Period	
Customer Information	Name		
	Address		
	Tel.		
Sales Offics (Distributor)	Name		
	Address		
	Tel.		

Warranty period is 60 months after date of invoice when used in a motor control application. Detailed warranty terms and conditions are available from Greenheck Fan Corp. or can be found at www.Greenheck.com

- **Warranty Service Information**

- If the defective part has been identified under normal and proper use within the warranty term, contact an authorized Greenheck Fan Crporation distributor.

- **Warranty is void if damage to the unit was caused by any of the following**

- Damage was caused by misuse, negligence, or accident.
- Damage was caused by abnormal voltage or peripheral devices' malfunction (failure).
- Damage was caused by improper repair, or altering by someone other than a Greenheck authorized distributor or service center.
- Damage was caused by an earthquake, fire, flooding, lightning, or other natural calamities.
- When Greenheck nameplate is not attached.
- When the warranty period has expired.