

Installation, Operation and Maintenance Manual

Please read and save these instructions for future reference. Read carefully before attempting to assemble, install, operate or maintain the product described. Protect yourself and others by observing all safety information. Failure to comply with these instructions will result in voiding of the product warranty and may result in personal injury and/or property damage.



Sure-Aire™ Electronics Features:

- NEMA-4/IP56 enclosure rating
- Factory calibrated
- 24 VDC / 24 VAC or 100-240 VAC 50/60 Hz input voltage
- Part numbers and pressure ranges:
 - 386719 – 0-4.15 in. wg
 - 386720 – 0-8.30 in. wg
 - 386721 – 0-22.14 in. wg
 - 386722 – 0-41.52 in. wg
 - 386723 – 0-83.14 in. wg
 - 386724 – 0-138.40 in. wg

Pressure ranges reflect differential pressures between the fan inlet and inlet cone, not system static pressure.

- Isolated output transmitter linear to differential pressure or volume
 - 4-20 mA
 - 2-10 VDC
- Communication protocols
 - BACnet MSTP
 - Modbus
- LCD display with user-friendly touch panel interface
- Temperature compensation for air density
- Remote duct temperature sensor
- Programmable elevation
- English or metric readings

Hardware Required:

- Four (4) #8-32 screws
- 1/4-inch nylon tubing (length dependent on distance between fan and Sure-Aire electronics, maximum 75 feet (23 m) each line)
- Sensor wiring for temperature sensor (if temperature sensor is being used)

Flow Accuracy +/- 3.0% of actual flow

Transducer in Electronics:

- Accuracy +/- 0.5% of full scale at 77°F (25°C)
- Pressure limit: 70 psi (1938 in. wg)
- Thermal effects: 0.015%/°F (0.027%/°C) from -13° thru 185°F (25° thru 85°C)

WARNING

Improper installation, adjustment, alterations, service or maintenance may cause injury and/or property damage, as well as possibly void the factory warranty. No person may install, operate, or maintain a Sure-Aire™ electronics without first being fully trained and qualified in the installation, operation and maintenance, and carefully reading and understanding the contents of this manual. If you have any questions about these instructions, contact your local representative.

CAUTION

Risk of electrical shock! More than one disconnect switch may be required to de-energize the equipment before servicing.

Table of Contents

- Label Information 2
- General Information 3
- Installation and Setup 3
- Menu Structure. 6
- Display Setting Options and Parameter Setup 8
- 4-20 mA Transmitter Calibration Procedure12
- 2-10 VDC Transmitter Calibration Procedure13
- Temperature Sensor14
- Network Protocol - Optional.14
- Analog Output Signal - Optional.15
- Calculation Using Manual Pressure Gauge or Third Party Transducer.15
- K-Factors.16

Label Information



CONFORMS TO
UL STD 81010-2-030
CERTIFIED TO
CAN/CSA STDC22.2 #61010-2-030

Intertek
3192905

Equipment For Measurement

Description: CNTRL, V2 SURE-AIRE,0-22.14"

Fan Model: 24-APH Fan Size: 24.0000

K Factor: 913.0000 Elevation: 886.0000

P/N: 386721 Tag Mark: SF-1

Sales Order: 8317009 Agent Order #: 7P/WP000896

P.O. #: 6896281/4501840282



Schofield, WI 54476 U.S.A. Date Code: 8/20

Input power
100-240Vac
50/60Hz

OR

Input power
24 VAC or DC
6VA MAX

3/BA 250vac
MEDIUM LAG

Line

Neutral

Earth Ground

TB1

1

2

3

F1

500mA
250vac

TB2

1

2

3

SLO
BLOW

TB3

RX (+)A

RX (-)B

TX (-)Z

TX (+)Y

SGND

Load Resistance

4-20mA (+)

2-10Vdc (-)

200-800 Ohms

Shield

Temperature Sensor

4

5

6

7

8

9

10

Match the Tag Mark on the Sure-Aire electronics tag to the Tag Mark on the fan nameplate. Sure-Aire electronics are supplied set-up individually for a specific model and performance. Contact factory if Sure-Aire electronics are being used on a different Tag Mark then specified.



General Information

This instruction manual provides installation, operating, maintenance, and other information for the Sure-Aire™ series differential pressure electronics.

Receiving

Upon receiving the electronics, check to ensure all items are accounted for by referencing the packing list. Inspect each crate or carton for shipping damage before accepting delivery. Alert the carrier of any damage detected. The customer will make notification of damage (or shortage of items) on the packing list and all copies of the bill of lading which is countersigned by the delivering carrier. If damaged, immediately contact your local sales representative. Any physical damage to the unit after acceptance is not the responsibility of the manufacturer.

Unpacking

Verify that all required parts and the correct quantity of each item have been received. If any items are missing, report shortages to your local representative to arrange for obtaining missing parts.

Storage

Electronics are protected against damage during shipment. If the electronics cannot be installed and operated immediately, precautions need to be taken to prevent deterioration during storage. The user assumes responsibility of the electronics and any accessories while in storage. The manufacturer will not be responsible for damage during storage. These suggestions are provided solely as a convenience to the user.

The ideal environment for the storage of electronics is indoors, above grade, in a low humidity atmosphere which is sealed to prevent the entry of blowing dust, rain or snow. Temperatures should be evenly maintained between 30° to 110°F (-1° to 43°C). Wide temperature swings may cause condensation and “sweating” of metal parts. All accessories must be stored indoors in a clean, dry atmosphere.

Removing from Storage

As electronics are removed from storage to be installed in their final location, they should be protected and maintained in a similar fashion until the control goes into operation. Environmental Operation Range: -4° to 140°F (-20° to 60°C).

Installation and Setup

WARNING

When wiring the electronics, you must follow industry standard practices for controls and protect against electrostatic discharge (ESD). Failure to exercise good ESD practices may cause damage to the electronics.

1. Mount the electronics in the vertical plane using four (4) #8-32 screws, field supplied. Open the front cover by unscrewing the two captive thumb screws to gain access to the four mounting locations.

Note: Mount the Sure-Aire™ electronics within 75 feet of the termination plate on the fan.

Dimensions and Hole Mounting Pattern

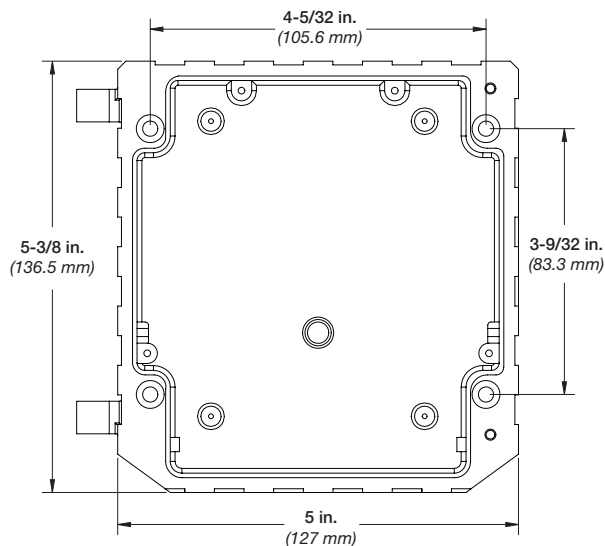

2. Use 1/4-inch nylon tubing to connect the corresponding High (H) and Low (L), 1/4-inch quick connect, pressure ports of the Sure-Aire electronics to the high and low pressure ports on the fan.



Installation and Setup (continued)

Wiring Diagram

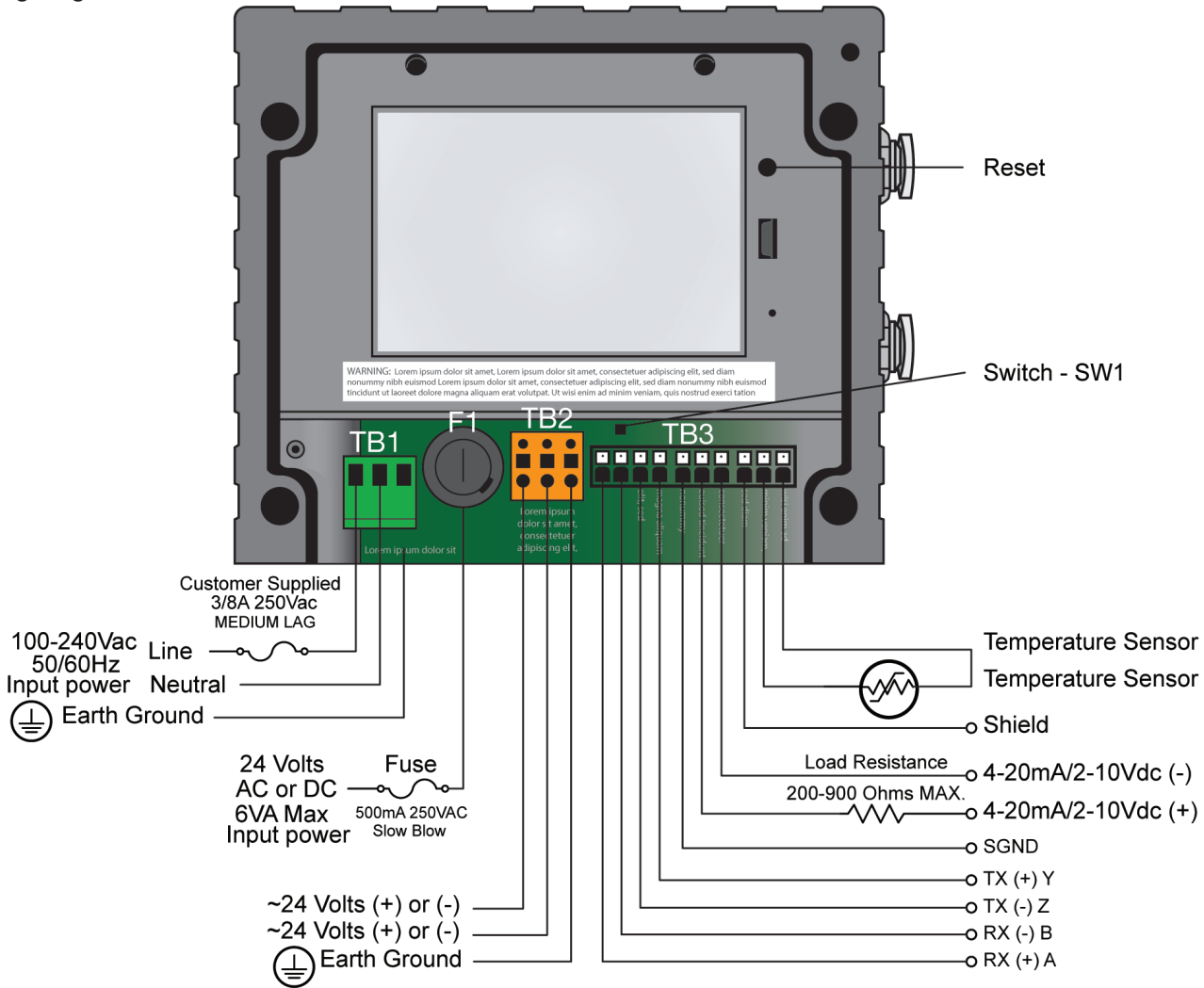

- Remove terminal block TB1 and perform wiring for the pins if you are using AC. If using low voltage AC/DC, plug the wires into TB2. For liquid tight applications, use only 1/2-inch liquid tight conduit.

Terminal Block TB1: AC Input Power:

- Pin 1 = 100-240VAC Line
- Pin 2 = 100-240VAC Neutral
- Pin 3 = Earth Ground

Terminal Block TB2: Low Voltage AC/DC Input Power:

- Pin 1 = 24V, AC or DC (+ or -)
- Pin 2 = 24V, AC or DC (+ or -)
- Pin 3 = Earth Ground

- Provide power to the electronics to turn it on.
- Select the desired Output Signal of the electronics for the Building Automation System. Use the touch screen to select the 4-20 mA or 2-10 VDC output signal via the monitor's setup menu. (Refer to Setup Menu, Output Signal, page 9).
- Wire TB3 appropriately for the selected Output Signal in Step 5.

Terminal Block TB3: Transmitter/Temperature Sensor:

- Pin 6 = 4-20 mA or 2-10 VDC (+) (output)

Note: 4 to 20 mA requires a load resistor 200-900 ohms

- Pin 7 = 4-20 mA or 2-10 VDC (+) (output)
- Pin 8 = Shield
- Pin 9 = Remote Temperature Sensor (input)
- Pin 10 = Remote Temperature Sensor (input)

Note: Signal isolator may be required when two or more output signals share a common connections at the PLC/electronics.

- Select the desired network protocol of the electronics for the Building Automation System. Use the touch screen to select Modbus/BACnet, baud rate, and the network address of the electronics. This is done via the setup menu. (Refer to Setup Menu, Output Signal, page 9)

8. Wire TB3 appropriately if the networking features of the electronics are being used. There are two wiring options for the network protocol: 2-Wire and 4-Wire. The currently selected option is based on the position of SW1.

Switch SW1: 2-Wire/4-Wire Select:

Left Position = 2-Wire
 Right Position = 4-Wire

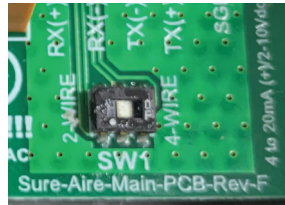

Terminal Block TB3: 4-Wire Communication:

- Pin 1: RX+ (A)
- Pin 2: RX- (B)
- Pin 3: TX- (Z)
- Pin 4: TX+ (Y)
- Pin 5: Signal Ground (SGND)

Terminal Block TB3: 2-Wire Communication:

- Pin 1 or Pin 4: RX+ (A)/TX+ (Z)
- Pin 2 or Pin 3: RX- (B)/TX- (Y)
- Pin 5: Signal Ground (SGND)

9. If not using temperature compensation, change Temperature Compensation to “No” via the setup menu. If temperature compensation is desired, mount the provided temperature sensor in contact with the airstream. Wire the temperature sensor into TB3 and confirm Temperature Comp is “Yes” via the setup menu. (Refer to Setup Menu, Temperature Compensation, page 9).
10. When the above steps are completed, make sure the front cover is properly aligned to the housing and the two captive thumbscrews are securely tightened.

2-Wire RS485 Wiring Diagram

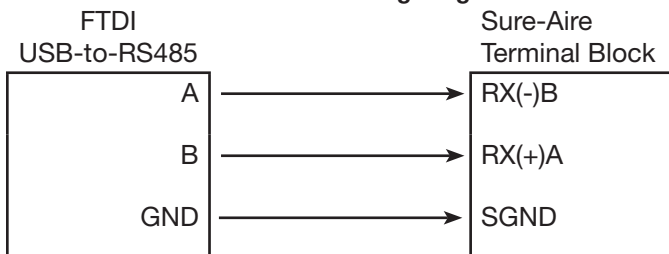

4-Wire RS485 Wiring Diagram

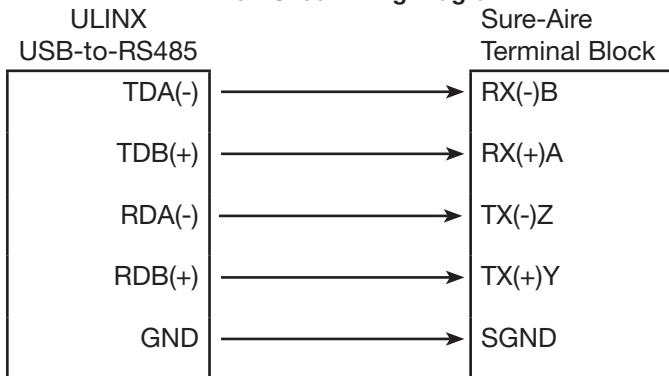

Network Input Register Address

| Object Name | Modbus | BACnet |
|------------------|----------------|----------------|
| | 16-bit address | 16-bit address |
| K Factor | 0 | 0 |
| Elevation | 1 | 1 |
| Outlet Area | 3 | 2 |
| Flow Temperature | 2 | 3 |
| Pressure | 4 | 4 |
| Volume | 5 | 5 |
| Velocity | 6 | 6 |

Menu Structure

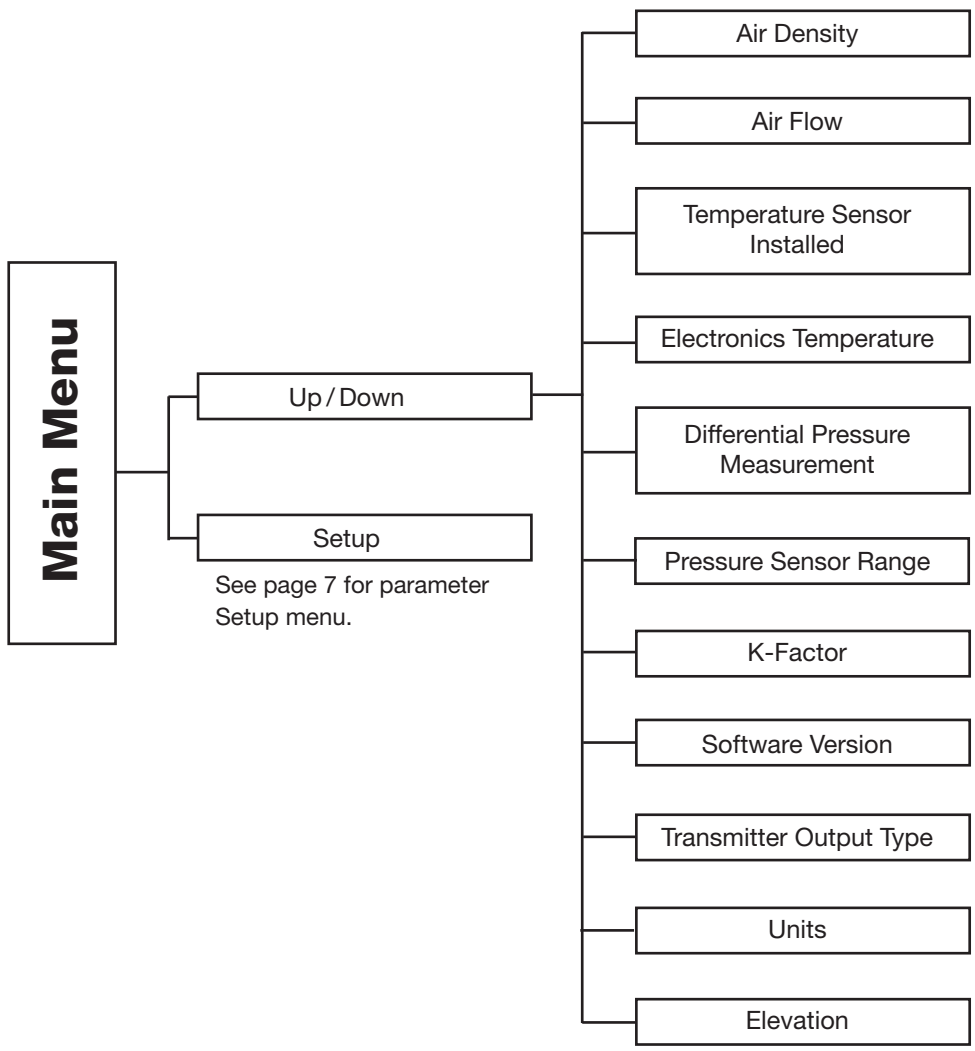

Setup

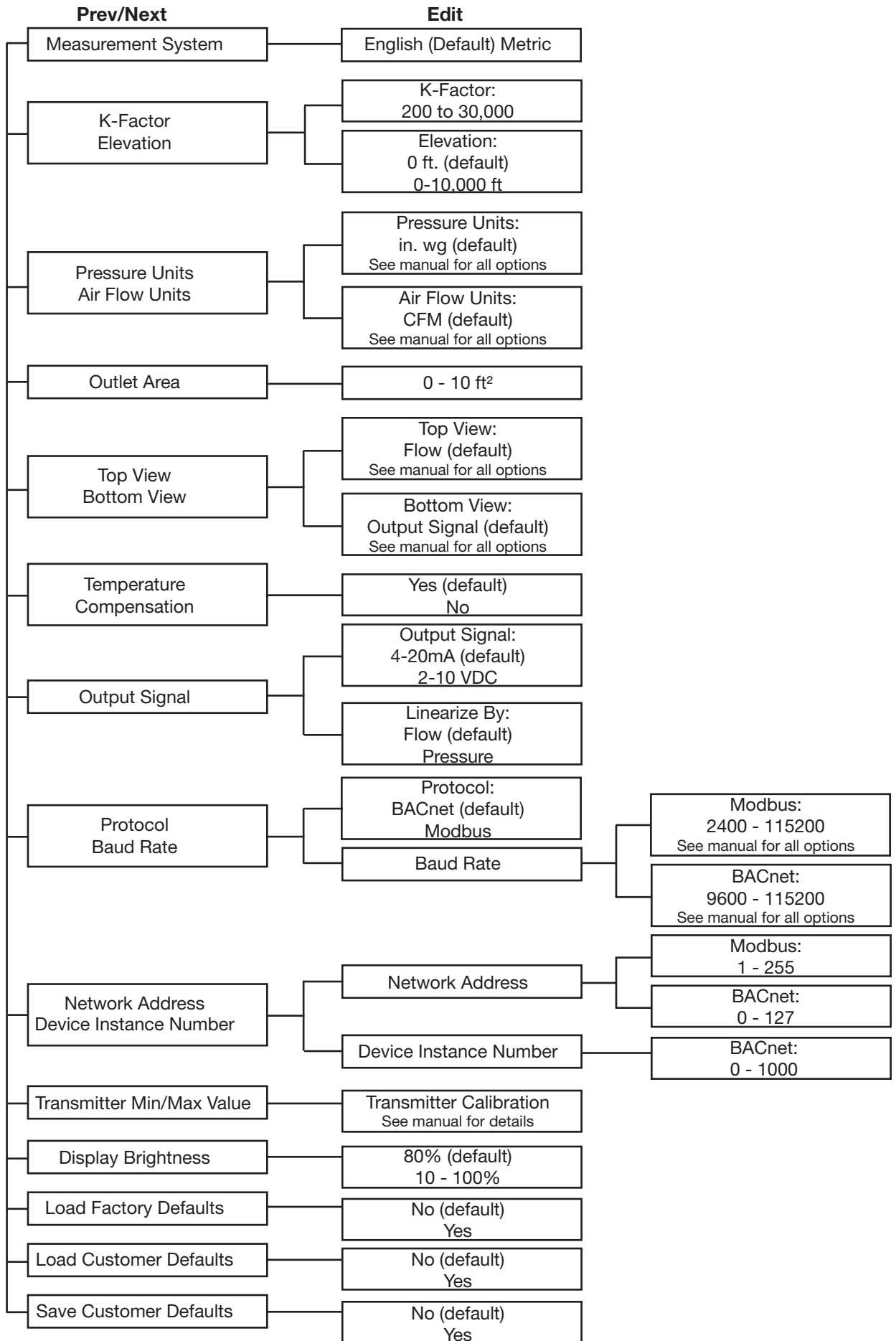

Display Setting Options and Parameter Setup

Navigation Buttons

The monitor is equipped with a touchscreen LCD display. There are 4 navigation buttons on the bottom of the screen. Button names will change based on the parameter you are in (i.e. "Setup" will change to "Home" and "Home" will change to "Edit").

Home Screen

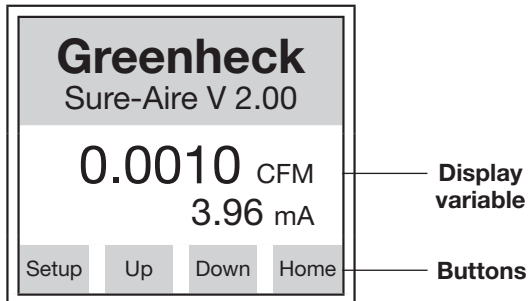

To view display variables, use the "Up" and "Down" buttons to scroll through the list. To adjust parameters, press "Setup" and scroll through the settings.

- Air density
- Flow
- Temperature sensor installed
- Electronics temperature
- Differential pressure measurement
- Pressure sensor range
- K-Factor
- Software version
- Transmitter output type
- Units
- Elevation

Press "Home" to return to the main screen.

Setup Menu

Following is information on the adjustable parameters that can be changed in the Setup menu of the electronics.

Measurement System

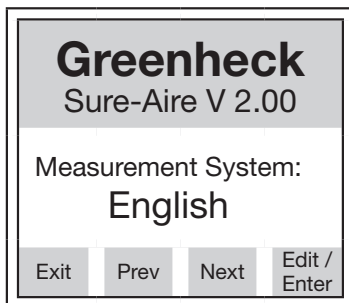

Press "Edit" to change the measurement system units. Press "Prev" or "Next" to adjust, then press "Enter" to store the value.

- English (default)
- Metric

K-Factor and Elevation

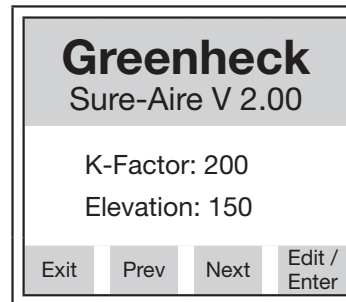

K-Factor: Press "Edit" to change K-Factor. Press "Inc" or "Dec" to adjust, then press "Enter" to store the value.

- 200 to 30,000
(Factory set to fan model and size)

Elevation: Press "Edit" to change elevation. Press "Inc" or "Dec" to adjust, then press "Enter" to store the value.

- 0 - 10,000 ft
(0 ft default)

Pressure and Air Flow Units

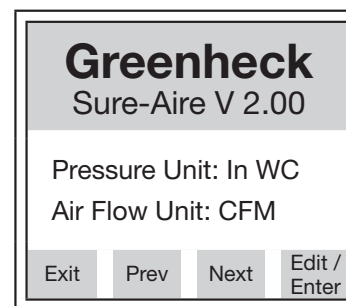

Pressure Units: Press "Edit" to change pressure units. Press "Prev" or "Next" to adjust, then press "Enter" to store the value.

- In. wg (default)
- Ft wg
- mm wg
- cm wg
- PSI
- In. Hg
- mm Hg
- mBar
- Pa
- kPa - kilopascals (1kPa = 1000 Pa)
- hPa - hectopascals (1hPA = 100 Pa)
- Oz. In.

Air Flow Units: Press "Edit" to change Air Flow Units. Press "Prev" or "Next" to adjust, then press Enter to store the value.

- CFM (default)
- m³/hr
- m³/min

Outlet Area

Greenheck
Sure-Aire V 2.00

Outlet Area: 1.00Ft²
For Outlet Velocity

Exit Prev Next Edit / Enter

Press “Edit” to change the stack outlet area. Press “Inc” or “Dec” to increase or decrease the area, respectively. Then press “Enter” to store the value.

- 0-10 Ft²

Top and Bottom Views

Greenheck
Sure-Aire V 2.00

Top View: Flow
Bottom View: Velocity

Exit Prev Next Edit / Enter

Top View: Press “Edit” to change Main Display Value. Press “Prev” or “Next” to adjust what reading displays on the Home screen, then press “Enter” to store the value.

- Flow (default top display)
- Pressure
- Temperature
- Air density
- Output signal (default bottom display)
- Velocity
- None

Bottom View: Press “Edit” to change Secondary Display. Press “Prev” or “Next” to adjust, then press “Enter” to store the value.

Temperature Compensation

Greenheck
Sure-Aire V 2.00

Temperature Comp:
No

Exit Prev Next Edit / Enter

Press “Edit” to change Temperature Compensation. Press “Prev” or “Next” to adjust, then press “Enter” to store the value.

- Yes (default)
- No

Note: If temperature compensation is set to “No”, the air density will be a function of standard temperature (70°F/21°C).

Output Signal

Greenheck
Sure-Aire V 2.00

Output Signal: 2-10V
Linearize By: Flow
Max Flow = 1400 CFM

Exit Prev Next Edit / Enter

Output Signal: Press “Edit” to change Output Signal type. Press “Prev” or “Next” to adjust, then press “Enter” to store the value.

- 4-20 mA (default)
- 2-10 VDC

Linearize By: Press “Edit” to change the linearization settings. The electronics will linearize the transmitter output with respect to this setting.

- Flow (default)
- Pressure

Note: The maximum measurable flow rate will automatically calculate based on the electronics settings. The maximum flow rate is displayed on the screen.

WARNING

Due to load resistance change from product to product, it may be necessary to recalibrate the 4-20 mA electronics. See 4-20 mA transducer calibration procedure.

Display Setting Options and Parameter Setup (continued)

Protocol and Baud Rate

Greenheck
Sure-Aire V 2.00

Protocol: Modbus
Baud Rate: 38400

Exit Prev Next Edit / Enter

Protocol: Press “Edit” to change the current network protocol. Press “Prev” or “Next” to adjust, then press “Enter” to store the value.

- BACnet (default)
- Modbus

Baud Rate: Press “Edit” to change the protocol baud rate. Press “Prev” or “Next” to adjust, then press “Enter” to store the value.

Baud Rate Options (Modbus):

- 2400
- 4800
- 9600
- 19200
- 38400
- 57600
- 115200

Baud Rate Options (BACnet):

- 9600
- 19200
- 38400
- 57600
- 76800
- 115200

Network Address

Greenheck
Sure-Aire V 2.00

Network Address:
10

Exit Prev Next Edit / Enter

Press “Edit” to adjust the network address, then press “Enter” to store the value.

Network Address Options (Modbus):

- 1 – 255

Network Address Options (BACnet):

- 0 – 127

Note: The protocol and baud rate must be set before the network address can be modified.

Device Instance Number (BACnet only):

The instance number is an unsigned decimal number that can range from 0 to 4,194,302. Every device on a BACnet network gets an instance number, and two devices must not have the same number.

Press “Edit” to adjust the Device Instance Number, then press “Enter” to store the value.

- 0 - 4,194,302

Transmitter Min/Max Value

Greenheck
Sure-Aire V 2.00

Trans Min: 1858
Trans Max: 822

Exit Prev Next Edit / Enter

Transmitter Min Value: Press “Edit” to change Transmitter Min Value. Press “Inc” or “Dec” to adjust, then press “Enter” to store the value.

Note: See Transmitter Calibration Section.

Transmitter Max Value: Press “Edit” to change Transmitter Max Value. Press “Inc” or “Dec” to adjust, then press “Enter” to store the value.

Note: See Transmitter Calibration Section.

Display Brightness

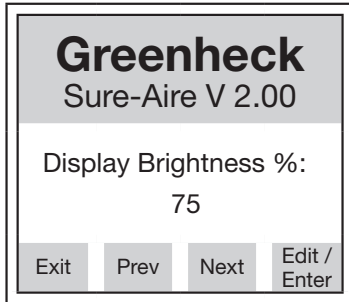

Press “Edit” to change brightness. Press “Inc” or “Dec” to adjust, then press “Enter” to store the value.

- 10 - 100%
(80% default)

Load Factory Defaults

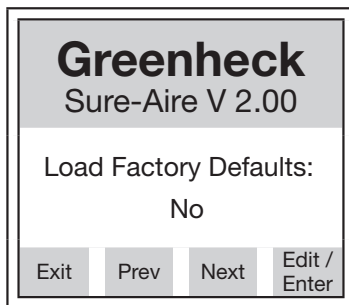

Press “Edit” to load factory defaults. Press “Prev” or “Next” to select “Yes”, then press “Enter”.

- No (default)
- Yes (changes all settings to factory default)

Load Customer Defaults

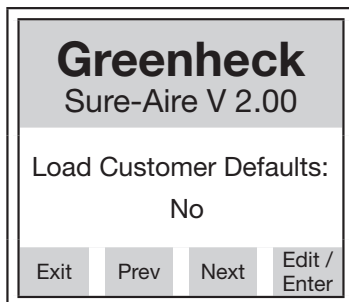

Press “Edit” to load customer defaults. Press “Prev” or “Next” to select “Yes”, then press “Enter”.

- No (default)
- Yes (loads all customer default settings)

Save Customer Defaults

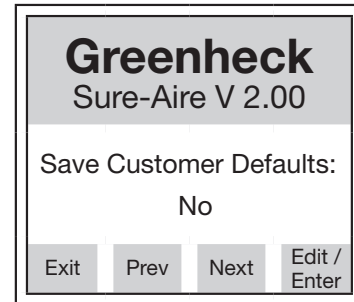

Press “Edit” to save current electronics settings as the customer default.

Press “Prev” or “Next” to select “Yes”, then press “Enter”.

- No (default)
- Yes (saves current settings as the customer default)

4-20 mA Transmitter Calibration Procedure

WARNING

Due to load resistance change from product to product, it may be necessary to recalibrate the 4-20 mA transmitter.

1. Test Equipment

- 1.1 Digital multimeter - set multimeter to read mA DC.
- 1.2 Load resistor - select a series load resistor between 200 and 900 ohms.

2. Interconnect wiring

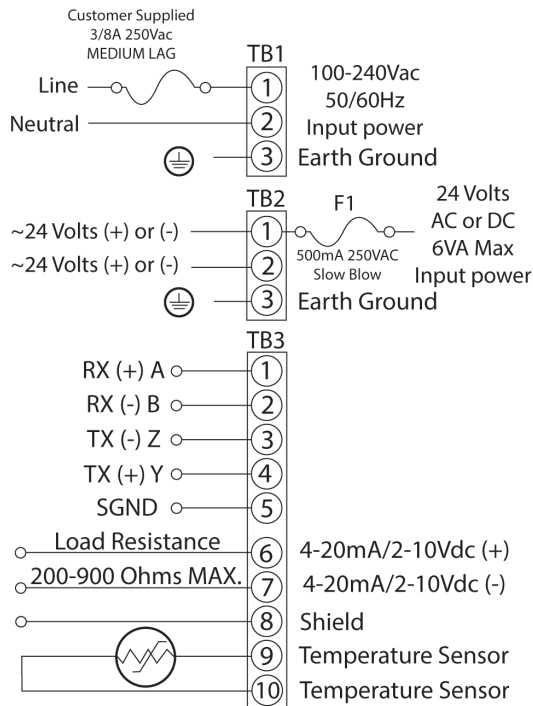

- 2.1 Validate the electronics is set up for 4-20 mA output signal.
- 2.2 Validate the power is OFF on the DC power supply and the Sure-Aire electronics.
- 2.3 Validate the multimeter is set to read mA DC.
- 2.4 Select a series Load Resistor between 200 and 900 ohms and install one end to TB3-6.
- 2.5 Interconnect the multimeter (+) probe to the other end of the load resistor.
- 2.6 Interconnect the multimeter (-) probe to TB3-7 to complete the current loop.
- 2.7 Apply power to the Sure-Aire electronics.
- 2.8 Press the “Setup” button on the touch panel interface.

- 2.9 Keep pressing the “Next” button until you reach the Transmitter Min Value parameter screen.

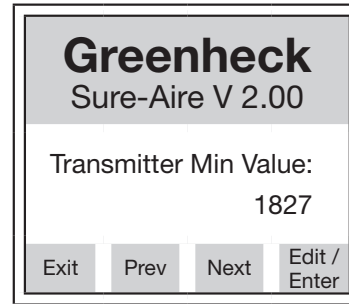

- 2.10 Press “Edit”, then “Inc” or “Dec” until the digital multimeter reads exactly 4.00 mA.
- 2.11 Press “Enter” to store the new value.
- 2.12 Press “Next”.

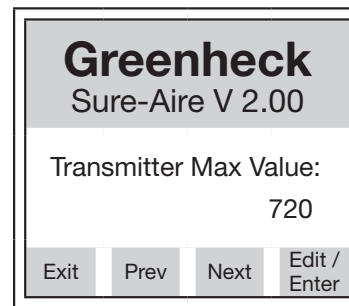

- 2.13 On the Transmitter Max Value screen, press “Edit”, then “Inc” or “Dec” until the digital multimeter reads exactly 20.00 mA.
 - 2.14 Press “Enter” to store the new value.
 - 2.15 Press “Exit” to return to the main screen.
- The 4-20 mA transmitter calibration is complete.

NOTE

Apply a vacuum to the Low Port and the 4-20 mA transmitter to track the span of the pressure range.

For example, the Sure-Aire electronics with a pressure sensor of 0 - 41.51 in. wg installed, 4.00 mA = 0 in. wg, 20.00 mA = 41.52 in. wg.

2-10 VDC Transmitter Calibration Procedure

1. Test Equipment

- 1.1 Digital multimeter - set multimeter to read DC voltage.
- 1.2 Make sure Output Signal type is set to 2-10 VDC.

2. Interconnect wiring

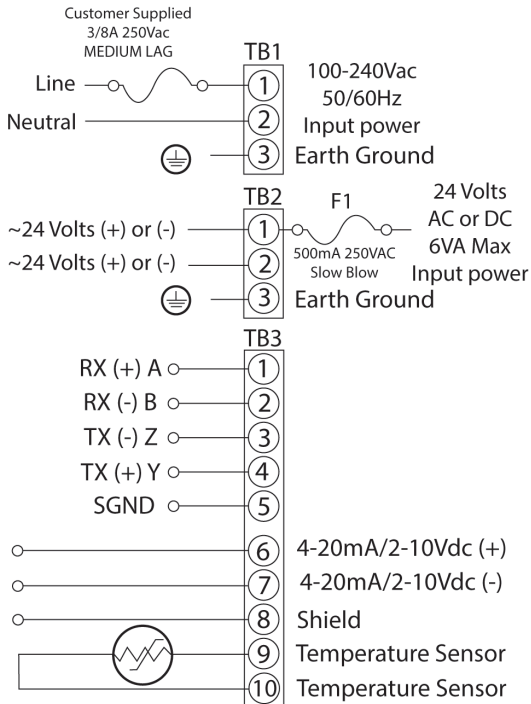

- 2.1 Validate the power is OFF on the DC power supply and the Sure-Aire electronics.
- 2.2 Validate the multimeter is set to read DC voltage.
- 2.3 Interconnect the multimeter (+) probe to TB3-6.
- 2.4 Interconnect the multimeter (-) probe to TB3-7.
- 2.5 Apply power to the Sure-Aire electronics.
- 2.6 Press the “Setup” button on the touch panel interface.
- 2.7 Keep pressing the “Next” button until you reach the Transmitter Min Value screen.

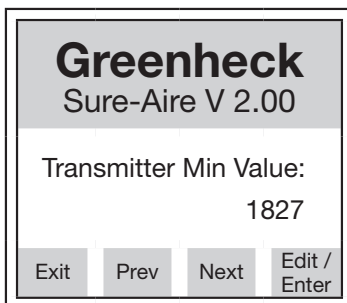

- 2.8 Press “Edit”, then “Inc” or “Dec” until the digital multimeter reads exactly 2.00 VDC.
- 2.9 Press “Enter” to store the new value.

2.10 Press “Next”.

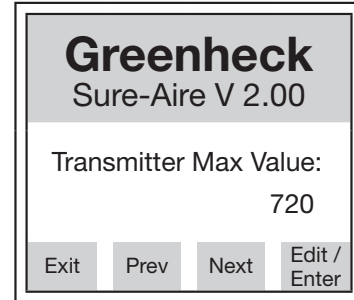

- 2.11 On the Transmitter Max Value screen, press “Enter”, then “Inc” or “Dec” until the digital multimeter reads exactly 10.00 mA.
- 2.12 Press “Enter” to store the new value.
- 2.13 Press “Exit” to return to the main screen.

The 2-10 VDC transmitter calibration is complete.

NOTE

Apply a vacuum to the Low Port and the 2-10 VDC transmitter to track the span of the pressure range.

For example, the Sure-Aire electronics with a pressure sensor of 0 - 41.51 in. wg installed, 2 VDC = 0 in. wg, 10 VDC = 41.52 in. wg.

Temperature Sensor

Interconnect the remote temperature sensor by connecting the temperature sensor to pins 4 and 5 of TB2. The Remote Temperature Sensor will adjust the air density value in the differential pressure electronics based on the sensor measurement when Temperature Compensation is set to “Yes”. This density compensation will affect the flow rate accordingly. If Temperature Compensation is set to “No”, the air density value will be a function of standard air. (70°F/21°C).

Network Protocol - Optional

Greenheck’s Sure-Aire™ electronics has the ability to connect to a Building Automation System (BAS) through the on-board RS-485 port. The electronics can be configured as either BACnet MS/TP or Modbus RTU Slave. When in the display menu, scroll through the options until the Network Protocol screen. Pressing edit will permit changing the network protocol type and associated data. This information should be set to match the BAS.

BACnet MS/TP Server

When the electronics is configured for BACnet, it will expose a total of eight (8) objects on the network.

| BACnet MS/TP Server Device Settings | |
|-------------------------------------|------------------------|
| Setting | Value |
| Baud Rate | Set to match BMS |
| Parity | No Parity (1 Stop Bit) |
| APDU Timeout (ms) | 1000 |
| Number of APDU Retries | 3 |
| Max Master Address | 127 |
| Max Info Frames | 1 |

| BACnet MS/TP Server Objects | | | |
|-----------------------------|---------------|-----------------------|-------|
| Object Name | Object Type | Data Type | Units |
| Sure-Aire™ | Device Object | N/A | N/A |
| K-Factor | Analog Input | 16-Bit Unsigned | None |
| Elevation | Analog Input | 16-Bit Unsigned | None |
| Outlet Area | Analog Input | 32-Bit Floating Point | None |
| Flow Temperature | Analog Input | 16-Bit Signed | None |
| Pressure | Analog Input | 32-Bit Floating Point | None |
| Volume | Analog Input | 32-Bit Floating Point | None |
| Velocity | Analog Input | 32-Bit Floating Point | None |

Modbus RTU Slave

When the electronics is configured for Modbus, it will expose a total of seven (7) registers on the network. The Modbus RTU Slave settings and list of registers can be seen below.

| Modbus RTU Slave Device Settings | |
|----------------------------------|------------------------|
| Setting | Value |
| Baud Rate | Set to match BMS |
| Parity | No Parity (1 Stop Bit) |
| Timeout (ms) | 0 |
| Response Delay (ms) | 0 |

| Modbus RTU Slave Registers | | | |
|----------------------------|----------------|-----------------|-------|
| Register Name | Register Type | Data Type | Units |
| K-Factor | Input Register | 16-Bit Unsigned | None |
| Elevation | Input Register | 16-Bit Unsigned | None |
| Outlet Area | Input Register | 16-Bit Unsigned | None |
| Flow Temperature | Input Register | 16-Bit Unsigned | None |
| Pressure | Input Register | 16-Bit Unsigned | None |
| Volume | Input Register | 16-Bit Unsigned | None |
| Velocity | Input Register | 16-Bit Unsigned | None |

NOTE

All of the objects/registers that are exposed on the network do not have a unit associated with them. The units of the values exposed on the network will be based on the units that are selected on the Sure-Aire™ electronics.

Analog Output Signal - Optional

Greenheck's Sure-Aire™ differential pressure electronics provides either a 2-10 VDC or 4-20 mA analog output signal. The output signal can be configured linearly proportional to either the pressure range or the flow within the setup. The ranges for Greenheck's Sure-Aire™ electronics are listed by model on cover.

Calculation Using Manual Pressure Gauge or Third Party Transducer

Calculating Flow from Differential Pressure

The volumetric flow through the fan (cfm) can be calculated from the equation:

$$CFM = K \sqrt{\frac{\Delta P}{\rho}}$$

where K is the K-Factor for the specific fan model and size, ΔP is the measured differential pressure across the inlet cone (in. wg), and ρ is the density of air (lb/ft³ °F). K-Factors for Greenheck models are found on the back cover.

Calculating Flow from Voltage Signal

If using the analog signal linear to flow, the max flow is automatically calculated based on the pressure range and K-factor input into the electronics. The max value is displayed in the setup menu.

If output signal is linear to pressure, the corresponding equations are used to calculate the flow.

Calculating flow for 2-10 VDC output signal:

$$CFM = K \sqrt{\frac{(V - 2) P_{\max}}{8\rho}}$$

| | |
|------------------|--|
| K | Constant dependent on fan model and size (see page 9) |
| P _{max} | Maximum pressure of electronics (in. wg) |
| ρ | Air density (lb/ft ³ °F) [0.075 at 70°F and 0 ft elevation] |
| V | Output voltage of 2-10 VDC signal |
| mA | Output current of 4-20 mA signal |

Calculating flow for 4-20 mA output signal:

$$CFM = K \sqrt{\frac{(mA - 4) P_{\max}}{16\rho}}$$

Density Corrections

Air density, ρ , is affected by elevation and temperature. The Sure-Aire differential pressure electronics allows the user to input the elevation for the application. This elevation input automatically updates the density used for the flow calculation.

The Remote Temperature sensor will adjust the air density value in the electronics based on the sensor measurement when Temperature Compensation is set to "Yes". This density compensation will affect the flow rate displayed on the transmitter. If Temperature Compensation is set to "No", the air density value will be a function of standard air (70°F/21°C).

The density being used by the Sure-Aire differential pressure measurement can be viewed on the main menu by scrolling up or down through the settings.

K-Factors

| Size | APD | Size | APH / APM HPA | AFDW / BIDW | FJI | QEI / QEID | USF-500 & Vektor-C series | Vektor-H Belt Drive | Vektor-M series |
|------|------|------|------------------|----------------|----------------|----------------|---------------------------------|------------------------|-----------------|
| 315 | 257 | 7 | not applicable | not applicable | 179 | not applicable | 179 | not applicable | not applicable |
| 355 | 329 | 8 | not applicable | not applicable | 179 | not applicable | 179 | not applicable | not applicable |
| 400 | 406 | 9 | not applicable | not applicable | 179 | 408 | 179 | 248 | not applicable |
| 450 | 536 | 10 | not applicable | not applicable | 179 | not applicable | 179 | 202 | not applicable |
| 500 | 652 | 12 | 355 | 592 | 244 | 408 | 244 | 296 | not applicable |
| 560 | 847 | 13 | not applicable | 701 | not applicable | not applicable | 296 | 351 | not applicable |
| 630 | 1053 | 15 | 355 | 861 | 366 | 603 | 366 | not applicable | 526 |
| | | 16 | 421 | 1062 | not applicable | 724 | 443 | 531 | 634 |
| | | 18 | 517 | 1083 | 542 | 897 | 542 | | 787 |
| | | 20 | 617 | 1301 | 651 | 1088 | 651 | not applicable | 955 |
| | | 22 | 759 | 1610 | 805 | 1321 | 805 | | 1161 |
| | | 24 | 913 | 1964 | 976 | 1631 | 976 | | 1436 |
| | | 27 | 1105 | 2369 | not applicable | 1962 | 1186 | not applicable | 1729 |
| | | 30 | 1355 | 2928 | not applicable | 2400 | 1464 | | 2116 |
| | | 33 | 1625 | 3540 | not applicable | 2923 | 1771 | not applicable | 2581 |
| | | 36 | 1967 | 4336 | not applicable | 3576 | 2167 | | 3154 |
| | | 40 | 2361 | 5259 | not applicable | 4331 | 2635 | not applicable | 3825 |
| | | 44 | 2854 | 6440 | not applicable | 5318 | 3220 | not applicable | 4698 |
| | | 49 | 3411 | 7808 | not applicable | 6525 | 3905 | not applicable | 5766 |
| | | 54 | 4121 | 9571 | not applicable | 7891 | 4786 | not applicable | 6975 |
| | | 60 | 4972 | 11707 | not applicable | 9648 | 5855 | not applicable | not applicable |
| | | 66 | 5960 | 14166 | not applicable | not applicable | 7084 | not applicable | not applicable |
| | | 73 | 7276 | 17330 | not applicable | not applicable | 8667 | not applicable | not applicable |

Vektor-H Direct Drive

| Fan Size | Nozzle Size | | | | | | | | | | | | | | | |
|----------|-------------|-----|-----|-----|-----|-----|-----|-----|-----|-----|-----|-----|-----|-----|-----|-----|
| | 4 | 5 | 6 | 7 | 8 | 9 | 10 | 11 | 12 | 13 | 14 | 15 | 16 | 17 | 18 | 19 |
| 10 | 136 | 142 | 150 | 152 | 154 | 157 | 160 | - | - | - | - | - | - | - | - | - |
| 12 | 161 | 172 | 185 | 188 | 191 | 194 | 195 | 196 | 197 | - | - | - | - | - | - | - |
| 13 | - | - | - | 230 | 233 | 236 | 238 | 239 | 240 | 241 | - | - | - | - | - | - |
| 14 | - | - | - | - | 335 | 339 | 344 | 345 | 346 | 347 | 348 | - | - | - | - | - |
| 16 | - | - | - | - | 353 | 386 | 422 | 428 | 434 | 435 | 435 | 437 | 440 | - | - | - |
| 18 | - | - | - | - | - | 527 | 530 | 535 | 538 | 542 | 545 | 549 | 546 | 543 | 546 | 550 |
| 20 | - | - | - | - | - | 616 | 629 | 643 | 648 | 654 | 659 | 666 | 666 | 666 | 665 | 664 |

Our Commitment

As a result of our commitment to continuous improvement, Greenheck reserves the right to change specifications without notice.

Product warranties can be found online at Greenheck.com, either on the specific product page or in the literature section of the website at Greenheck.com/Resources/Library/Literature.

Greenheck's Sure-Aire™ Flow Monitoring System catalog provides additional information describing the equipment, fan performance, available accessories, and specification data.

AMCA Publication 410-96, Safety Practices for Users and Installers of Industrial and Commercial Fans, provides additional safety information. This publication can be obtained from AMCA International, Inc. at www.amca.org.

